

LED for Automotive, Consumer and Industry Applications

Safety Instructions

The use of new chip technologies means that OSRAM LEDs are delivering higher and higher levels of optical performance. Thus, even eye safety issues might increasingly need to be considered. In general, the EU product safety legislation requires conformity with EC directives (such as the "Low Voltage Directive") which define the "essential requirements", e.g., protection of health and safety, that goods must meet when they are placed on the market. We therefore recommend that the current version of the IEC 62471 standard is taken into account right from the outset, i.e. at the equipment development stage, and that suitable protection facilities are provided in your laboratories.

Eye Safety Information

The light output of modern High-Power-LEDs is strong enough for eye irritation and temporal blinding effects. Therefore, in general, do not stare into the light beam of any LED at close range. Optical radiation hazards by LED-based lamps, lamp systems or luminaires have to be assessed and classified according to the requirements of IEC62471 ("Photobiological safety of lamps and lamp systems").

Within the risk grouping system of this IEC standard, most LEDs specified in this catalogue fall into the "exempt" group. However, high-power "blue" LEDs and the most important "white" LEDs for general lighting may need some attention. Due to their dominating photochemical hazard potential, extensive deliberate long-term direct viewing from close distance can indeed be hazardous. Under worst case conditions of classification, these high power light sources can even be allocated to the "moderate risk group" i.e. safety bases on aversion reactions against bright light. However, under real circumstances (for exposure time, eye pupils, observation distance), it is assumed that no endangerment to the eye exists from these devices. This is valid for single LEDs under the mentioned conditions and operating conditions defined in the data sheet. Complex Multi-LED-designs, additional optics or extreme application conditions demand a separate evaluation of the entire system.

As a matter of principle, however, it should be mentioned that intense light sources have a high secondary exposure potential due to their blinding effect. As for any bright light source, when viewing into it (e.g. headlights), temporary reduction in visual acuity and afterimages can occur, leading to irritation, annoyance, visual impairment, and even accidents, depending on the situation.

Remarks:

User shall not reverse engineer by disassembling or analysis of the LEDs without having the prior written consent of OSRAM Opto Semiconductors GmbH. When defective LEDs are found, user shall inform to OSRAM Opto Semiconductors GmbH directly before disassembling or analysis.

The appearance and specifications of the product may be modified for improvement without notice.

Sicherheitshinweise

OSRAM LEDs erreichen aufgrund von neuen Chip-Technologien immer höhere optische Leistungen. Deshalb müssen auch Sicherheitsaspekte bezüglich Augensicherheit zunehmend in Betracht gezogen werden. Generell fordern die EU Produkt-Sicherheitsgesetze Konformität mit den EU Richtlinien (z.B. die "Niederspannungsrichtlinie"), die wesentliche Forderungen festlegen, z.B. an Sicherheit und Gesundheitsschutz, die die auf den Markt gebrachten Produkte erfüllen müssen. Wir empfehlen daher, schon bei der Entwicklung von Geräten, die zu diesem Zeitpunkt gültige Norm IEC 62471 zu beachten und insbesondere auf den Gebrauch von entsprechenden Schutzvorrichtungen in Ihren Labors hinzuweisen.

Informationen zur Augensicherheit

Die Lichtausbeute der modernen Hochleistung-LEDs ist stark genug, um Augenreizungen und zeitliche Blindheitseffekte hervorzurufen. Daher sollten Sie generell nicht aus kurzer Entfernung in den Lichtstrahl jeglicher LED blicken. Risiken durch optische Strahlung, die durch LED-basierte Lampen, Lampen-Systeme oder Leuchter entstehen, müssen eingeschätzt und nach der Forderungen des IEC62471 Standards ("Photobiological safety of lamps and lamp systems") bewertet werden.

Im Rahmen des Risikogruppensystems des IEC Standards fallen die meisten in diesem Katalog beschriebenen LEDs in die "exempt" (befreit) Gruppe. Jedoch sollten hochleistungsfähige blaue LEDs und die wichtigsten weißen LEDs näher betrachtet werden. Auf Grund ihres hohen photochemischen Risiko-Potenzials kann das langfristige, bewusste, direkte Ansehen gefährlich sein. Bei ungünstigsten Bedingungen der Anordnung können die Hochleistungs-LEDs sogar der "moderate risk group" (gemäßigte Risikogruppe) zugeordnet werden, d.h. die Sicherheit beruht auf Aversions-Reaktionen auf helles Licht. Unter realen Umständen (in Bezug auf Belichtungszeit, Pupillen, Betrachtungsabstand) kann jedoch angenommen werden, dass keine Gefahr für die Augen von diesen Geräten ausgeht. Dies gilt für einzelne LEDs unter den genannten Konditionen und im Datenblatt definierten Betriebsbedingungen. Komplexe Multi-LED Designs, zusätzliche Optik oder außergewöhnliche Anwendungsbedingungen fordern eine gesonderte Bewertung des ganzen Systems.

Prinzipiell ist jedoch zu erwähnen, dass starke Lichtquellen auf Grund ihrer Blendwirkung ein hohes, sekundäres Gefahrenpotenzial besitzen. Wie bei jeder hellen Lichtquelle kann das direkte Anschauen (z.B. Scheinwerfer) zur Reduzierung der Sehschärfe oder zu Nachbildern führen, was Reizungen, Irritationen und sogar Unfälle verursachen kann.

Anmerkungen:

Der Anwender darf keinen Ausbau oder Analyse der LEDs vornehmen, ohne die vorherige schriftliche Zustimmung von OSRAM Opto Semiconductors GmbH zu haben. Wenn defekte LEDs gefunden werden, soll der Anwender baldmöglichst OSRAM Opto Semiconductors GmbH informieren, bevor er einen Ausbau oder eine Analyse vornimmt. Erscheinungsform und technische Daten des Produktes können zwecks Verbesserung ohne Benachrichtigung geändert werden.

Automotive Applications

Exterior

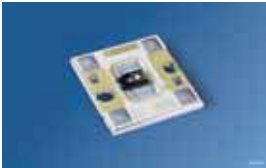

OSRAM OSTAR Headlamp

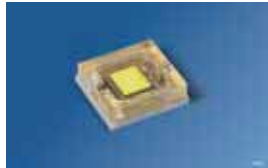

OSRAM OSTAR Compact



OSLON ECE



OSLON Black Flat



OSLON Black



Golden DRAGON



Platinum DRAGON



Advanced Power TOPLED



Power TOPLED



Power TOPLED



MULTILED



Multi TOPLED

Interior



OSLON

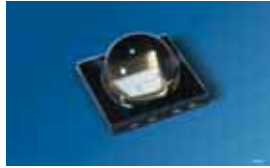

OSLON Black



Advanced Power TOPLED



Power TOPLED



Power TOPLED



TOPLED



SIDELED



Mini TOPLED



SMARTLED



SMARTLED XR



PointLED



Micro SIDELED



MULTILED



Multi TOPLED

Consumer Applications

Mobile Applications

Page 36

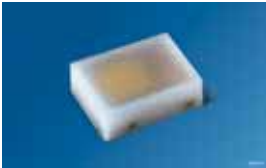

CERAMOS



FIREFLY

Backlighting

Page 37



Multi CERAMOS



Micro SIDELED

Industry Applications

Projection

Page 38



OSRAM OSTAR Projection Cube



OSRAM OSTAR Projection Power

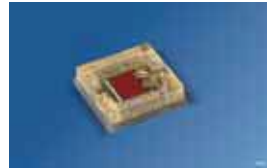

OSRAM OSTAR Projection Compact

Signs and Signals

Page 41



OSLON SX

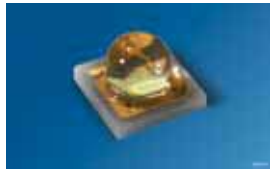

OSLON Signal

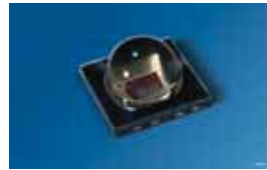

OSLON Black



Golden DRAGON



Platinum DRAGON



TOPLED



TOPLED Black



MULTILED



Multi CERAMOS



Multi CHIPLD

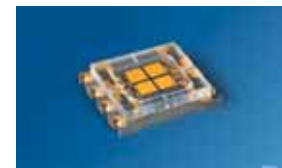

OSRAM OSTAR SMT

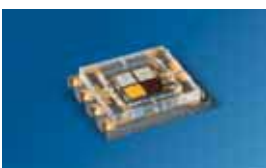

OSRAM OSTAR Stage

Electronic Equipment



Advanced Power TOPLED Plus



Power TOPLED



Power TOPLED



TOPLED



SIDELED



Mini TOPLED



CHIPLED 1206



CHIPLED 0805



CHIPLED 0603



CHIPLED 0402



CHIPLED with lens



SMARTLED



SMARTLED XR



PointLED



FIREFLY



Micro SIDELED



MULTILED



Multi TOPLED

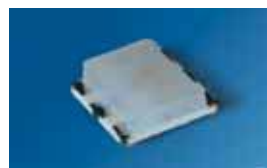

Multi CHIPLED



TOPLED Compact

White Goods

Page 62



Golden DRAGON



TOPLED



SIDELED

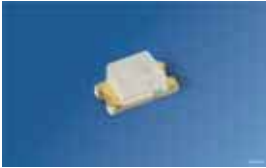

CHIPLED 0603



Micro SIDELED

Transportation

Page 65

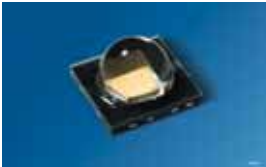

OSLON Black



OSRAM OSTAR Headlamp





Advanced Power TOPLED Plus

Automotive Applications

Exterior

OSRAM OSTAR Headlamp

Package	Type	Emission color	Color coordinates Cx/Cy typ.	Φ_V	at I_f	Viewing angle at 50 % I_V 2ϕ typ. [°]	Ordering Code	Package Fig.
				[lm]	[mA]			
	LE UW D1W1 01-5L6M-GMKM-T01	○ ultra white	0.31 / 0.32	112 ... 224	700	120	Q65110A8591	1
	LE UW D1W2 01-7M7N-GMKM-T01			224 ... 400			Q65110A8590	
	LE UW D1W3 01-7N7P-GMKM-T01			355 ... 630			Q65110A8588	
	LE UW D1W4 01-5P6Q-GMKM-T01			450 ... 900			Q65110A8593	
	LE UW D1W5 01-7P8Q-GMKM-T01			560 ... 1120			Q65110A8589	
	LE UW U1A2 01-5P8P-ebvF68ebzB68	○ ultra white	0.322 / 0.334	450 ... 710	1000	120	Q65111A2089	1
	LE UW U1A3 01-8P8Q-ebvF68ebzB68			630 ... 1120			Q65111A2088	
	LE UW U1A4 01-7Q6R-ebvF68ebzB68			900 ... 1400			Q65111A2087	
	LE UW U1A5 01-5R8R-ebvF68ebzB68			1120 ... 1800			Q65111A2086	

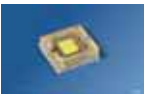

OSRAM OSTAR Compact

Package	Type	Emission color	λ_{dom} (typ.) / Cx/Cy	Φ_V	at I_f	Viewing angle at 50 % I_V 2ϕ typ. [°]	Ordering Code	Package Fig.
			[nm / -]	[lm]	[mA]			
	LE UW Q9WP-8M7N-GMKM	○ ultra white	0.31 / 0.32	250 ... 400	1400	120	Q65110A9235	2

Automotive Applications

Exterior

OSLON ECE

Package	Type	Emission color	λ_{dom} (typ.)/ Cx/Cy	at f			Viewing angle at 50 % I_V 2 ϕ typ. [°]	Ordering Code	Package Fig.
				Φ_V	I_V typ.				
			[nm / -]	[lm]	[cd]	[mA]			
	LUW CN7M-HYJY-EMKM-1	○ ultra white	0.32 / 0.32	33 ... 61	32.9	200	90	Q65110A9509	3
	LUW CN7N-KYLX-EMKM-46	○ ultra white	0.32 / 0.32	82 ... 130	56.2	350	80	Q65110A9810	3

OSLON Black Flat

Package	Type	Emission color	λ_{dom} (typ.)/ Cx/Cy	at f			Viewing angle at 50 % I_V 2 ϕ typ. [°]	Ordering Code	Package Fig.
				Φ_V	I_V typ.				
			[nm / -]	[lm]	[cd]	[mA]			
	LUW H9QP-8L7M-HNJJN-1	○ ultra white	0.322 / 0.334	159 ... 250	67.5	700	120	Q65111A1706	4

OSLON Black

Package	Type	Emission color	λ_{dom} (typ.)/ Cx/Cy	at f			Viewing angle at 50 % I_V 2 ϕ typ. [°]	Ordering Code	Package Fig.
				Φ_V	I_V typ.				
			[nm / -]	[lm]	[cd]	[mA]			
	LA H9GP-JYKY-24-1	● amber	617	52 ... 97	36.6	350	90	Q65111A1982	5
	LR H9GP-HZKX-1-1	● red	625	39 ... 82	29.7			Q65111A1707	
	LY H9GP-HZKX-36-1	● yellow	590					Q65111A1708	
	LS H9GP-HYJY-1-9B9C	● super red	633	33 ... 61	23.1			Q65111A2566	



Automotive Applications

Exterior

DRAGON



Package	Type	Emission color	λ_{dom} (typ.)/ Cx/Cy				Viewing angle at 50 % I_V 2 ϕ typ. [°]	Ordering Code	Package Fig.
				Φ_V	I_V typ.	at ϕ			
			[nm / -]	[lm]	[cd]	[mA]			

Golden DRAGON

	LR W5SM-HZJZ-1-1	● red	625	39 ... 71	18.2	400	120	Q65111A2604	6
	LA W5SM-JYKY-24-1	● amber	617	52 ... 97	24.6			Q65111A2606	
	LY W5SM-HZJZ-36-1	● yellow	590	39 ... 71	18.2			Q65111A2600	
	LY W5SM-HZJZ-46-1							Q65111A2817	
	LUW W5SM-JZKZ-6P7Q-1	○ ultra white	0.31 / 0.32	61 ... 112	28.5	350	120	Q65111A2586	7
	LUW W5SM-KXLX-5P7R-1			71 ... 130	33.2			Q65111A2585	
	LW W5SM-JYKY-JKQL-1	○ white	0.33 / 0.33	52 ... 97	24.6			350	
	LCY W5SM-HZJZ-5E-1	● color on demand yellow	0.56 / 0.42	39 ... 71	18.2	350	120	Q65111A2605	7

Package	Type	Emission color	λ_{dom} (typ.)/ Cx/Cy				Viewing angle at 50 % I_V 2 ϕ typ. [°]	Ordering Code	Package Fig.
				Φ_V	I_V typ.	at ϕ			
			[nm / -]	[lm]	[cd]	[mA]			



Platinum DRAGON

	LR W5SN-JYKY-1	● red	625	52 ... 97	24.6	700	120	Q65110A6011	8
	LA W5SN-JZKZ-24	● amber	617	61 ... 112	28.5			Q65110A6010	
	LY W5SN-KXLX-35	● yellow	590	71 ... 130	33.2			Q65111A0327	
	LY W5SN-KXLX-46							Q65111A0328	
	LY W5SN-JYKY-46							52 ... 97	
	LW W5SN-KYLY-JKQL	○ white	0.33 / 0.33	82 ... 150	38.3	700	120	Q65110A8946	8





Automotive Applications

Exterior

Advanced Power TOPLED

Package	Type	Emission color	λ_{dom} (typ.)/ Cx/Cy	at φ			Viewing angle at 50 % I_V 2 φ typ. [°]	Ordering Code	Package Fig.
				I_V	Φ_V typ.	[mA]			
			[nm / -]	[mcd]	[mlm]				
	LA G6SP-DAEB-24-1	● amber	617	4500 ... 11200	24600	140	120	Q65111A0336	9
	LR G6SP-CBEA-1-1	● red	623	3550 ... 9000	19700				
	LY G6SP-CADB-36-1	● yellow	590	2800 ... 7100	15500				
	LS G6SP-CADB-1-1	● super red	630						
	LCY G6SP-CBDB-5E	● color on demand yellow	0.56 / 0.42	3550 ... 7100	16700	140	120	Q65110A8813	10
	LW G6CP-EAFA-JKQL-1	○ white	0.33 / 0.33	7100 ... 14000	33100	140	120	Q65110A8947	10

Power TOPLED

Package	Type	Emission color	λ_{dom} (typ.)/ Cx/Cy	at φ			Viewing angle at 50 % I_V 2 φ typ. [°]	Ordering Code	Package Fig.
				I_V	Φ_V typ.	[mA]			
			[nm / -]	[mcd]	[mlm]				
	LA E67F-BACA-24-3A4B	● amber	617	1800 ... 3550	8000	50	120	Q65110A9090	11
	LA E67F-BACA-24-3B5A							Q65110A9089	
	LY E67F-AABA-35-1	● yellow	590	1120 ... 2240	5000			Q65110A9019	
	LY E67F-ABBB-46-1							Q65110A9018	
	LS E67F-ABBB-1-1	● super red	633	1400 ... 2800	6300			Q65111A1118	
	LR E67F-ABCA-1-1	● red	625	1400 ... 3550	7400			Q65111A2785	
	LR E6SF-ABCA-1-1	● red	625	1400 ... 3550	7430	50	120	Q65111A0958	11
	LA E6SF-BBCB-24-1	● amber	617	2240 ... 4500	10110	900 ... 1800	4050	Q65110A6262	
	LY E6SF-V2AB-35-1	● yellow	590	1120 ... 2240	5040			Q65110A7525	
	LY E6SF-AABA-46-1							Q65110A6209	
	LA ETSF-BACB-24-1	● amber	617	1800 ... 4500	9500	50	120	Q65110A9777	11
	LY ETSF-ABCA-46-1	● yellow	590	1400 ... 3550	7400			Q65110A9779	
	LW ETSG-AABB-JKPL-1	○ white	0.33 / 0.33	1120 ... 2800	5900	30	120	Q65111A0196	12
	LW E6SG-AABA-JKPL-1	○ white	0.33 / 0.33	1120 ... 2240	5000	30	120	Q65110A8964	12

Automotive Applications

Exterior

Power TOPLED

Package	Type	Emission color	λ_{dom} (typ.)/ Cx/Cy	at φ			Viewing angle at 50° % I_V 2 φ typ.	Ordering Code	Package Fig.
				E_V	Φ_V typ.	[mA]			
			[nm / -]	[lux]	[mlm]		[°]		
	LA E63F-EBGA-24-3A4B	● amber	617	9000 ... 22400	6300	50	30	Q65110A4103	13
	LS E63F-DBFA-1	● super red	633	5600 ... 14000	3900			Q65110A4105	
	LY E63F-DBEB-35-1	● yellow	590	5600 ... 11200	3400			Q65110A4108	
	LY E63F-EAFA-46-1		7100 ... 14000	4200	Q65110A4107				

Package	Type	Emission color	λ_{dom} (typ.)/ Cx/Cy	at φ			Viewing angle at 50° % I_V 2 φ typ.	Ordering Code	Package Fig.
				I_V	Φ_V typ.	[mA]			
			[nm / -]	[mcd]	[mlm]		[°]		
	LS E65F-BBDA-1	● super red	633	2240 ... 5600	4500	50	60	Q65110A4106	14
	LA E65F-CBEA-24-3A4B	● amber	617	3550 ... 9000	7200			Q65110A4104	
	LY E65F-CBDB-35	● yellow	590	3550 ... 7100	6100			Q65110A6456	
	LY E65F-DAEB-46-1		4500 ... 11200	8900	Q65111A1412				

Automotive Applications

Exterior

MULTILED

Package	Type	Emission color	λ_{dom} (typ.)/ Cx/Cy [nm / -]	I_v			Viewing angle at 50 % I_v 2 ϕ typ. [°]	Ordering Code	Package Fig.
				[mcd]	Φ_v typ. [mlm]	at ξ [mA]			
	LYYYG6SF-CADB-45	● yellow	587	2800 ... 7100	14850	50	120	Q65110A8529	15



Multi TOPLED



Package	Type	Emission color	λ_{dom} (typ.) [nm]	I_v [mcd]			Viewing angle at 50 % I_v 2 ϕ typ. [°]	Ordering Code	Package Fig.
				color 1	color 2	at ξ [mA]			
	LAY T67F-AABB-1- 1+AABA-45-1	● amber ● yellow	617 / 590	1120 ... 2800	1120 ... 2240	50	120	Q65110A7526	16

Automotive Applications

Interior

OSLON



Package	Type	Emission color	λ_{dom} (typ.)/ Cx/Cy	at φ			Viewing angle at 50 % I_V 2 φ typ. [°]	Ordering Code	Package Fig.
				Φ_V	I_V typ.	[mA]			
			[nm / -]	[lm]	[cd]				
	LA CN5M-GAHA-24-1	 amber	617	18 ... 35.5	18.7	140	60	Q65111A1207	17
	LY CN5M-FAGA-36-1	 yellow	590	11.2 ... 22.4	11.8			Q65110A8680	
	LT CN5M-GAHB-25-1	 true green	528	18 ... 45	22.1	140	60	Q65110A9086	17
	LUW CN5M-GBHB-5P7R-1	 ultra white	0.32 / 0.31	22.4 ... 45	23.6	140	60	Q65111A3434	3

Package	Type	Emission color	λ_{dom} (typ.)/ Cx/Cy	at φ		Viewing angle at 50 % I_V 2 φ typ. [°]	Ordering Code	Package Fig.
				Φ_E	[mA]			
			[nm / -]	[mW]				
	LD CN5M-4Q4R-35-1	 deep blue	453	100 ... 180	140	60	Q65110A8683	17
	LD CN5M-1R1S-35-1			112 ... 201			Q65110A9085	

Automotive Applications

Interior

OSLON Black

Package	Type	Emission color	λ_{dom} (typ.)/ Cx/Cy	at φ			Viewing angle at 50 % I_V 2 φ typ. [°]	Ordering Code	Package Fig.
				Φ_V	I_V typ.	[mA]			
			[nm / -]	[lm]	[cd]				
	LB H9GP-GYHY-35-1	● blue	470	21 ... 39	15	350	90	Q65111A1710	5
	LT H9GP-JZKZ-26-1	● true green	528	61 ... 112	43.3			Q65111A1717	
	LCW H9GP-JZKY-4R9T-1	○ warm white	0.42 / 0.4	61 ... 97	38.7	350	90	Q65111A0920	5
	LCW H9GP-JZKZ-4O9Q-1			61 ... 112	42.4			Q65111A0921	
	LCW H9GP-KXLX-4J8K-1			71 ... 130	49.2			Q65111A0923	
	LCW H9GP-JZLX-4L8N-1			61 ... 130	46.8			Q65111A0922	
	LCW H9GP-JZKY-4U9X-1			61 ... 97	38.7			Q65111A0919	
	LUW H9GP-KYLY-4C8E-1	○ ultra white	0.31 / 0.32	82 ... 150	55.7	350	90	Q65111A0924	5
LUW H9GP-KYLY-5F8G-1	Q65111A0925								
LUW H9GP.CE-KYLY-EMKM-1	Q65111A1881								

Package	Type	Emission color	λ_{dom} (typ.)/ Cx/Cy	at φ		Viewing angle at 50 % I_V 2 φ typ. [°]	Ordering Code	Package Fig.
				Φ_E	[mA]			
			[nm / -]	[mW]				
	LD H9GP-3T2U-35-1	● deep blue	455	355 ... 560	350	90	Q65111A1709	5

Automotive Applications

Interior





Advanced Power TOPLED



Package	Type	Emission color	λ_{dom} (typ.)/ Cx/Cy	at φ			Viewing angle at 50° % I_V 2 φ typ. [°]	Ordering Code	Package Fig.
				I_V [mcd]	Φ_V typ. [mlm]	[mA]			
	LB G6SP-V2BB-35-1	● blue	470	900 ... 2800	5800	140	120	Q65110A4678	10
	LT G6SP-CBEB-25-1	● true green	528	3550 ... 11200	21900			Q65110A5874	
	LCB G6SP-DBFA-4J5L	● color on demand blue	0.2 / 0.3	5600 ... 14000	30800	140	120	Q65111A0342	10
	LW G6SP-EAFA-JKQL-1	○ white	0.33 / 0.33	7100 ... 14000	33100	140	120	Q65110A9043	10
	LCW G6CP-DAFA-4J8K	○ warm white	0.42 / 0.4	4500 ... 14000	29000	140	120	Q65111A0081	10
	LCW G6CP-DAFA-4L8N							Q65111A0082	
	LCW G6CP-DAFA-409Q							Q65111A0083	
	LCW G6CP-DAFA-4R9T							Q65111A0079	
	LCW G6CP-DAFA-4U9X							Q65111A0080	

Automotive Applications

Interior

Power TOPLED









Package	Type	Emission color	λ_{dom} (typ.)/ Cx/Cy	at φ			Viewing angle at 50 % I_V 2 φ typ. [°]	Ordering Code	Package Fig.
				I_V	Φ_V typ.	[mA]			
			[nm / -]	[mcd]	[mlm]				
	LO E67F-BADA-24-1	● orange	606	1800 ... 5600	11100	50	120	Q65111A0963	11
	LO E6SF-ABCB-24-1	● orange	606	1400 ... 4500	8850	50	120	Q65110A7524	11
	LB E6SG-T1U2-35	● blue	470	280 ... 710	1485	30	120	Q65110A7883	12
	LT E6SG-AABB-35-1	● true green	525	1120 ... 2800	5880			Q65111A0322	
	LCB E6SG-AABB-2J8L	● color on demand blue	0.2 / 0.3	1120 ... 2800	5880	30	120	on request	12
	LCW E6SG-V1AB-4R9T	○ warm white	0.42 / 0.4	710 ... 1800	3765	30	120	Q65110A7737	12
	LCW E6SG-V1AB-4U9X			Q65110A7736					
	LCW E6SG-V2BA-4L8N			900 ... 2240	4710			Q65110A7734	
	LCW E6SG-V2BA-4J8K			Q65110A7735					
LCW E6SG-V2BA-4O9Q	Q65110A7733								
	LP E675-P2R1-25	● pure green	560	56 ... 140	294	50	120	Q65110A7298	18

Package	Type	Emission color	λ_{dom} (typ.)/ Cx/Cy	at φ			Viewing angle at 50 % I_V 2 φ typ. [°]	Ordering Code	Package Fig.
				E_V	Φ_V typ.	[mA]			
			[nm / -]	[lux]	[mlm]				
	LO E63B-DAEB-24-1	● orange	606	4500 ... 11200	3900	50	30	Q65110A2338	19
	LB E63C-T2V2-35-34	● blue	469	355 ... 1120	400	30	20	Q65110A1974	20
	LT E63C-BADB-35-1	● true green	525	1800 ... 7100	2700			Q65110A1981	

Automotive Applications

Interior



TOPLED

Package	Type	Emission color	λ_{dom} (typ.)/ Cx/Cy	Viewing angle at 50°			Viewing angle at 50° % I_v 2 ϕ typ. [°]	Ordering Code	Package Fig.
				I_v [mcd]	Φ_v typ. [mlm]	at I_f [mA]			
		[nm / -]							
	LS T676-P2S1-1	● super red	633	56 ... 224	420	20	120	Q65110A2153	21
	LO T676-Q2T1-24	● orange	606	90 ... 355	670			Q65110A2150	
	LY T676-Q2T1-26	● yellow	587					Q65110A2156	
	LA T676-Q2T1-24	● amber	615					Q65110A9273	
	LS T67F-T2V2-1-1	● super red	633	355 ... 900	1880	20	120	Q65110A9233	21
	LR T67F-U1AA-1-1	● red	625	450 ... 1400	2780			Q65110A9232	
	LA T67F-U2AB-24-1	● amber	617	560 ... 1800	3540			Q65110A9268	
	LO T67F-V1AB-24-1	● orange	606	710 ... 1800	3770			Q65110A9230	
	LY T67F-U1AA-36-1	● yellow	590	450 ... 1400	2780			Q65110A9231	
	LP T67F-N1Q2-24	● pure green	560	28 ... 112	210			Q65111A1851	
	LP T67F-P1R2-35	● pure green		45 ... 180	340			Q65111A1852	
	LG T67F-R1T1-24	● green	570	112 ... 355	700			Q65111A1826	
	LB T673-L2P1-25	● blue	471	14 ... 56	105	10	120	Q65111A1007	21
	LT T673-N2S1-25	● true green	529	35.5 ... 224	390			Q65110A1968	
	LT T673-L2N2-35			14 ... 45	90			2	
	LCB T67S-P2R2-2J8L	● color on demand blue	0.2 / 0.3	56 ... 180	355	10	120	Q65111A2936	21
	LG T676-P1Q2-24	● green	570	45 ... 112	240	20	120	Q65110A2178	21
	LP T676-L1M2-25	● pure green	560	11.2 ... 28	60	20	120	Q65110A2179	21
	LG T67K-G2K1-24	● green	570	2.24 ... 9	16	2	120	Q65110A2184	21
	LP T67K-E1G2-25	● pure green	560	0.71 ... 2.8	5	2	120	Q65110A2187	21
	LH T674-L2P1-1	● hyper red	645	14 ... 56	105	10	120	Q65110A3596	21
	LW T673-P1S1-FKPL	○ white	0.33 / 0.33	45 ... 224	400	10	120	Q65111A2043	21
	LW T6SG-V2BA-JKPL	○ white	0.33 / 0.33	900 ... 2240	4710	20	120	Q65110A8982	52
	LW T6SG-V1AA-JKPL			710 ... 1400	3165			Q65110A8981	

Automotive Applications

Interior



TOPLED

Package	Type	Emission color	λ_{dom} (typ.)/ Cx/Cy	at φ			Viewing angle at 50 % I_V 2 ϕ typ. [°]	Ordering Code	Package Fig.		
				I_V [mcd]	Φ_V typ. [mlm]	[mA]					
	LA T67D-U2AA-24-1	● amber	617	560 ... 1400	2940	20	120	Q65110A9889	21		
	LO T67D-U2AA-24-1	● orange	606					Q65110A9919			
	LR T67D-U1V2-1-1	● red	625					450 ... 1120		2360	Q65110A9920
	LS T67D-T2V1-1-1	● super red	633					355 ... 900		1880	Q65110A9896
	LY T67D-U1V2-36-1	● yellow	590					450 ... 1120		2360	Q65110A9898
	LW TTSD-U1V1-JKPL-1	○ white	0.33 / 0.33	450 ... 900	2030	20	120	Q65111A0300	52		
	LW TTSD-U2V2-JKPL-1			560 ... 1120	2520			Q65111A0301			
	LCB TTSD-T2V1-2J8L	● color on demand blue	0.2 / 0.3	355 ... 900	1880	10	Q65111A1160				
	LB TTSD-R1T2-25-1	● blue	469	112 ... 450	810	20	120	Q65111A1639	52		
	LT TTSD-T2V2-36-1	● true green	525	355 ... 1120	2140	10		Q65111A2711			
	LW TVSG.BB-AZBZ-FBKC-1	○ white	0.33 / 0.34	1500 ... 2800	6500	20	120	Q65111A2884	24		
	LW TVSG.BB-BXCX-LBNC-1			1800 ... 3300	7700			Q65111A2473			
	LW TVSG.CB-AZBZ-JKPL-1		0.33 / 0.33	1500 ... 2800	6450			Q65111A2760			
	LW TVSG.CB-BXCX-JKPL-1			1800 ... 3300	7650			Q65111A3555			

Automotive Applications

Interior































SIDELED

Package	Type	Emission color	λ_{dom} (typ.)/ Cx/Cy	at φ			Viewing angle at 50° % I_V 2 φ typ. [°]	Ordering Code	Package Fig.
				I_V [mcd]	Φ_V typ. [mlm]	[mA]			
	LB A673-L2P1-35	● blue	470	14 ... 56	105	10	120	Q65110A1950	22
	LT A673-N2S1-25	● true green	529	35.5 ... 224	390			Q65110A1962	
	LT A6SG-V1AB-36	● true green	528	710 ... 1800	3765	20	120	Q65110A6030	53
	LT A6SG-V2AB-35			900 ... 1800	4050			Q65110A7884	
	LCB A6SG-U2AB	● color on demand blue	0.2 / 0.3	1800 ... 560	3540	20	120	on request	53
	LG A676-P1Q2-24	● green	570	45 ... 112	235	20	120	Q65110A2285	22
	LP A676-L1M2-25	● pure green	560	11.2 ... 28	60	20	120	Q65110A2286	22
	LG A67K-G2K1-24	● green	570	2.24 ... 9	15	2	120	Q65110A2291	22
	LP A67K-E1G2-25	● pure green	560	0.71 ... 2.8	5	2	120	Q65110A2294	22
	L0 A67K-K1M2-24	● orange	606	7.1 ... 28	55	2	120	Q65110A4969	22
	LS A67K-J1L2-1	● super red	630	4.5 ... 18	35			Q65110A2018	
	LY A67K-J2M1-26	● yellow	587	5.6 ... 22.4	40			Q65110A2067	
	LP A675-N1P2-25	● pure green	560	28 ... 71	150	30	120	Q65110A2310	22
	LS A67F-U1AA-1	● super red	633	450 ... 1400	2780	30	120	Q65110A4723	22
	LR A67F-U2AB-1	● red	625	560 ... 1800	3540			Q65110A4729	
	LA A67F-AABB-24-1	● amber	617	1120 ... 2800	5880			Q65111A0513	
	L0 A67F-V2BB-24	● orange	606	900 ... 2800	5550			Q65110A4867	
	LY A67F-U2AB-36	● yellow		560 ... 1800	3540			Q65110A4722	
	LS A676-P2S1-1	● super red	633	56 ... 224	420			Q65110A2261	
	LA A676-Q2T1-1	● amber	615	90 ... 355	670	20	120	Q65110A2255	22
	L0 A676-Q2T1-24	● orange	606					Q65110A2258	
LY A676-Q2T1-26	● yellow	587	Q65110A2264						
LW A673-P1S1-FKPL	○ white	0.33 / 0.33	45 ... 224					400	
	LW A67C-T2U2-5K8L	○ white	0.33 / 0.33	355 ... 710	1600	20	120	Q65110A1928	22
	LW A67C-S2U2-5K8L			224 ... 710	1400			Q65110A1929	
	LW A6SG-V2BA-JKPL	○ white	0.33 / 0.33	900 ... 2240	4710	20	120	Q65110A8994	53

Automotive Applications

Interior

Mini TOPLED

Package	Type	Emission color	λ_{dom} (typ.)/ Cx/Cy	at φ			Viewing angle at 50° $\% I_V$ 2 φ typ. [°]	Ordering Code	Package Fig.			
				I_V [mcd]	Φ_V typ. [mlm]	[mA]						
	LB M673-L1N2-25	 blue	471	11.2 ... 45	80	10	120	Q65111A1010	23			
	LT M673-N1R2-25	 true green	529	28 ... 180	310			Q65110A5930				
	LS M676-P2S1-1	 super red	633	56 ... 224	420	20	120	Q65110A2364	23			
	LA M676-Q2T1-1	 amber	615	90 ... 355	670			Q65110A2358				
	LO M676-Q2T1-24	 orange	606					Q65110A2361				
	LY M676-Q2T1-26	 yellow	587	Q65110A2367								
	LG M676-N2Q1-24	 green	570	35.5 ... 90	190			Q65110A2389				
	LP M676-L1M2-25	 pure green	560	11.2 ... 28	60			Q65110A7809				
	LCB M67S-K2M1-2J8L	 color on demand blue	0.2 / 0.3	9 ... 22.4	40	2	120	Q65111A2807	23			
	LG M676-N2Q1-24	 green	570	35.5 ... 90	190	20	120	Q65110A2389	23			
	LP M676-L1M2-25	 pure green	560	11.2 ... 28	60	20	120	Q65110A7809	23			
	LG M67K-G1J2-24	 green	570	1.8 ... 7.1	13.4	2	120	Q65110A2395	23			
	LP M67K-D2G1-25	 pure green	560	0.56 ... 2.24	4.2	2	120	Q65110A2398	23			
	LS M67K-H2L1-1	 super red	630	3.55 ... 14	25	2	120	Q65110A2028	23			
	LO M67K-J2M1-24	 orange	606	5.6 ... 22.4	42			Q65110A2055				
	LY M67K-J1L2-26	 yellow	587	4.5 ... 18	33.8			Q65110A2076				
	LG M67K-G1H2-24			1.8 ... 4.5	9.5			Q65110A2393				
	LG M67K-H1J2-24	 green	570	2.8 ... 7.1	14.8			Q65110A2394				
	LG M67K-G1J2-24			1.8 ... 7.1	13.4			Q65110A2395				
	LP M67K-D2F1-25			0.56 ... 1.4	2.9			Q65110A2396				
	LP M67K-E2G1-25	 pure green	560	0.9 ... 2.24	4.7			Q65110A2397				
	LP M67K-D2G1-25			0.56 ... 2.24	4.2			Q65110A2398				
	LP M675-M2P1-25	 pure green	560	22.4 ... 56	120			30		120	Q65110A2399	23
	LO M67F-U2AB-24	 orange	606	560 ... 1800	3540			20		120	Q65110A8973	23
	LS M67F-S2U2-1	 super red	633	224 ... 710	1400						Q65110A8888	
	LY M67F-T2V2-36	 yellow	590	355 ... 1120	2210	Q65110A8980						
	LA M67F-V1AB-24	 amber	617	710 ... 1800	3770	Q65111A1848						
	LW M673-P1R2-FKPL	 white	0.33 / 0.33	45 ... 180	340	10	120		Q65111A2039		23	
	LW M67C-S1T2-5K8L			180 ... 450	950	20	120	Q65110A1936	23			
	LW M67C-T1U2-5K8L	 white	0.33 / 0.33	280 ... 710	1490			Q65110A1937				
	LW M67C-S1U2-5K8L			180 ... 710	1340			Q65110A1938				



Automotive Applications

Interior

Mini TOPLED

Package	Type	Emission color	λ_{dom} (typ.)/ Cx/Cy	at φ			Viewing angle at 50 % I_V 2 ϕ typ. [°]	Ordering Code	Package Fig.
				I_V	Φ_V typ.				
			[nm / -]	[mcd]	[mlm]	[mA]			
	LCW MTSG-U2V2-4L8N	○ warm white	0.38 / 0.38	560 ... 1120	2520	10	120	Q65111A2101	28

SMARTLED

Package	Type	Emission color	λ_{dom} (typ.)/ Cx/Cy	at φ			Viewing angle at 50 % I_V 2 ϕ typ. [°]	Ordering Code	Package Fig.
				I_V	Φ_V typ.				
			[nm / -]	[mcd]	[mlm]	[mA]			
	LG L29K-F2J1-24	● green	570	1.4 ... 5.6	14	2	160	Q65110A1745	25
	LS L29K-G1J2-1	● super red	630	1.8 ... 7.1	18			Q65110A1757	
	L0 L29K-H2L1-24	● orange	606	3.55 ... 14	35			Q65110A1751	
	LY L29K-H1K2-26	● yellow	587	2.8 ... 11.2	28			Q65110A1766	
	LS L296-N1Q2-1	● super red	633	28 ... 112	280	20	160	Q65110A1754	25
	LA L296-P1R2	● amber	615	45 ... 180	450			Q65110A3235	
	L0 L296-P1S1-24	● orange	606	45 ... 224	538			Q65110A1905	
	LY L296-P1R2-26	● yellow	587	45 ... 180	450			Q65110A1764	
	LP L296-J2L2-25	● pure green	560	5.6 ... 18	35			Q65110A3342	
	LW L283-Q1R2-3K8L-1	○ white	0.32 / 0.31	71 ... 180	502	10	170 (horizontal) 130 (vertical)	Q65110A1647	25
	LW L283-P2R1-3K8L-1			56 ... 140	392			Q65110A1550	



SMARTLED XR

	LS L196-N1R2-1	● super red	633	28 ... 180	430	20	150	Q65111A0708	26
	LY L196-P1S1-26	● yellow	587	45 ... 224	555			Q65111A0703	

Automotive Applications

Interior









PointLED

Package	Type	Emission color	λ_{dom} (typ.)/ Cx/Cy	at φ			Viewing angle at 50° % I_V 2 φ typ. [°]	Ordering Code	Package Fig.
				I_V [mcd]	Φ_V typ. [mlm]	[mA]			
	LS P47F-U1AA-1-1	● super red	633	450 ... 1400	2780	30	120	Q65110A4859	27
	LR P47F-U2AB-1-1	● red	625	560 ... 1800	3540			Q65110A4861	
	LA P47F-V2BB-24-3A4B	● amber	617	900 ... 2800	5550			Q65110A4857	
	LA P47F-V2BB-24-3B5A							Q65110A9267	
	LY P47F-U2AB-36-4A5B	● yellow	590	560 ... 1800	3540			Q65110A9266	
	LY P47F-U2AB-36-3B5A							Q65110A4860	
	LP P47F-P2S1-35	● pure green	560	56 ... 224	420			Q65111A1828	
	LP P47F-P1R1-24			45 ... 140	280			Q65111A1827	
	LB P4SG-S2U1-35-1	● blue	470	224 ... 560	1180	20	120	Q65110A8252	27
	LT P4SG-V1AB-36-1	● true green	528	710 ... 1800	3770			Q65110A7127	
	LCB P473-P2R2	● color on demand blue	0.2 / 0.3	180 ... 56	350	10	120	on request	54
	LO P476-R2T1-24	● orange	606	140 ... 355	740	20	120	Q65110A7018	54
	LY P476-Q2T1-26	● yellow	587	90 ... 355	670	20	120	Q65110A4881	54
	LS P47K-H1K2-1	● super red	630	2.8 ... 11.2	21	2	120	Q65110A2733	54
	LY P47K-J1L2-26	● yellow	587	4.5 ... 18	34			Q65110A2738	
	LG P47K-G2K1-24	● green	570	2.24 ... 9	17			Q65110A2730	
	LW P473-Q2S1-FKPL-1	○ white	0.33 / 0.33	90 ... 224	470	10	120	Q65111A2066	54
	LW P4SG-V2AB-JKPL-1	○ white	0.33 / 0.33	900 ... 1800	4050	20	120	Q65110A9047	27



Automotive Applications

Interior











Micro SIDELED

Package	Type	Emission color	λ_{dom} (typ.)/ Cx/Cy	I_v			Viewing angle at 50 % I_v 2 ϕ typ. [°]	Ordering Code	Package Fig.
				[nm / -]	[mcd]	Φ_v typ. [mlm]			
	LS Y876-P2S1-1	 super red	633	56 ... 224	420	20	120	Q65110A2412	29
	LO Y876-Q2T1-24	 orange	606	90 ... 355	670				
	LY Y876-Q2T1-26	 yellow	587						
	LG Y876-P1Q2-24	 green	570	45 ... 112	240				
	LR Y8SF-U1V2-1	 red	625	450 ... 1120	2400	20	120	Q65110A8972	29
	LY Y8SF-U1V2-36	 yellow	590					Q65110A8977	

MULTILED

Package	Type	Emission color	Cx/Cy	I_v		Viewing angle at 50 % I_v 2 ϕ typ. [°]	Ordering Code	Package Fig.
				[mcd]	at ϕ [mA]			
	LTRBGFSF-ABCB-QKYO	 white	0.31 / 0.31	1400 ... 4500	20 (T) 20 (R) 10 (B)	120	Q65110A9484	42





Multi TOPLED

Package	Type	Emission color	λ_{dom} (typ.)	I_v [mcd]		at ϕ [mA]	Viewing angle at 50 % I_v 2 ϕ typ. [°]	Ordering Code	Package Fig.
				color 1	color 2				
	LOG T77K-JL-1-0+GJ-1	 orange  green	606 / 570	4.5 ... 18	1.8 ... 7.1	2	120	Q65110A3338	51
	LSG T77K-JL-1-0+HK-1-0	 super red  green	630 / 570	4.5 ... 18	2.8 ... 11.2	2	120	Q65111A0238	51
	LSY T676-P2R1-1-0+Q2S1-35	 super red  yellow	633 / 587	56 ... 140	90 ... 224	20	120	Q65110A2446	16
	LSG T676-P7Q7-1+N7P7-24	 super red  green	633 / 570	56 ... 140	35.5 ... 90	20	120	Q65110A4186	16
	LSG T676-P7R-1-0+N7P9-24			56 ... 180	35.5 ... 100			Q65111A1615	



Consumer Applications

Mobile Applications

CERAMOS

Package	Type	Emission color	λ_{dom} (typ.)/ Cx/Cy	at φ			Viewing angle at 50 % I_V 2 φ typ. [°]	Ordering Code	Package Fig.
				Φ_V	I_V typ.				
			[nm / -]	[lm]	[cd]	[mA]			
	LUW C9EP-7K6L-EG	○ ultra white	0.31 / 0.32	90 ... 140	38	500	120	Q65111A1126	30
	LUW C9SP-8K6L-EG	○ ultra white	0.31 / 0.32	100 ... 140	39.6	500	120	Q65111A1127	30
	LUW C9EN-N4N6-EG	○ ultra white	0.31 / 0.32	75 ... 105	28	500	120	Q65110A9846	30
	LUW CAEP-LFLZ-G3-E	○ ultra white	0.33 / 0.36	125 ... 180	45.8	500	120	Q65111A0768	55
	LUW CAEP.G4-MXMZ-G3-1	○ ultra white	0.33 / 0.36	180 ... 280	69	1000	120	Q65111A2947	55
	LUW CAEP.G4-MYNX-G3-1			210 ... 330	81			Q65111A1991	

FIREFLY

Package	Type	Emission color	λ_{dom} (typ.)/ Cx/Cy	at φ			Viewing angle at 50 % I_V 2 φ typ. [°]	Ordering Code	Package Fig.
				I_V	Φ_V typ.				
			[nm / -]	[mcd]	[mlm]	[mA]			
	LT VH9G-Q2S2-25-1	● true green	532	90 ... 280	560	5	140 (horizontal) 165 (vertical)	Q65110A9228	31
	LB VH9G-N1P2-35-1	● blue	470	28 ... 71	150			Q65110A8083	
	LW VH8G-Q2S2-4M6N-1	○ white	0.285 / 0.275	90 ... 280	560	5	140 (horizontal) 180 (vertical)	Q65110A8090	31
	LA VH9F-Q1R2-24	● amber	615	71 ... 180	380	5	140 (horizontal) 165 (vertical)	Q65110A8082	31
	LR VH9F-P2R1-1	● red	625	56 ... 140	290			Q65110A8088	

Consumer Applications

Backlighting

Multi CERAMOS

Package	Type	Emission color	Cx/Cy	at φ		Viewing angle at 50 % I_V 2 ϕ typ. [°]	Ordering Code	Package Fig.
				I_V [mcd]	[mA]			
	LRTDC9TP-EAFB-GHQN	○ white	0.28 / 0.21	7100 ... 18000	140 (R) 160 (T) 125 (D)	120	Q65110A8562	32

Micro SIDELED

Package	Type	Emission color	λ_{dom} (typ.)/ Cx/Cy [nm / -]	at φ			Viewing angle at 50 % I_V 2 ϕ typ. [°]	Ordering Code	Package Fig.
				I_V [mcd]	Φ_V typ. [mlm]	[mA]			
	LW Y1SG-AEBE-EKFM-1	○ white	0.3 / 0.28	1000 ... 1600	3900	20	120	Q65110A9541	64
	LW Y1SG-AEBE-GKJM-1							Q65110A9542	
	LW Y1SG-AFBF-EKFM-1							Q65110A9543	
	LW Y1SG-AFBF-GKJM-1							Q65110A9544	
	LW Y1SG-BFCF-EKFM-1							Q65110A9545	
	LW Y1SG-BFCF-GKJM-1							Q65110A9546	





Industry Applications

Projection

OSRAM OSTAR Projection





Package	Type	Emission color	Color coordinates Cx/Cy typ.	Φ_V	at φ	Viewing angle at 50 % I_V 2 φ typ. [°]	Ordering Code	Package Fig.
				[lm]	[mA]			

OSRAM OSTAR Projection Cube

	LCG H9RM-KZLZ-1	 converted green	0.318 / 0.642	97 ... 180	350	120	Q65111A1779	33
	LCG H9RN-MXNX-1	 converted green	0.318 / 0.642	180 ... 330	700	120	Q65111A1778	33

Package	Type	Emission color	λ_{dom} (typ.)/ Cx/Cy	Φ_V	at φ	Viewing angle at 50 % I_V 2 φ typ. [°]	Ordering Code	Package Fig.
			[nm / -]	[lm]	[mA]			

OSRAM OSTAR Projection Power

	LE A P3W-TXTZ-1	 amber	617	2800 ... 4500	6000	120	Q65110A9038	66
	LE CG P3W-8U6V-1	 converted green	0.318 / 0.642	6300 ... 9000	6000	130	Q65111A1846	66
	LE B P3W-GXHX-24	 blue	459	18 ... 33	6000	120	Q65110A9036	66

Industry Applications

Projection

OSRAM OSTAR Projection

Package	Type	Emission color	λ_{dom} (typ.)/ Cx/Cy [nm / -]	Φ_V	at ξ	Viewing angle at 50 % I_V 2 ϕ typ. [°]	Ordering Code	Package Fig.
				[lm]	[mA]			

OSRAM OSTAR Projection Compact

	LE A Q9WM-HYJY-1	● amber	617	33 ... 61	350	120	Q65111A1647	35
	LE T Q9WM-JXKX-25	● true green	525	45 ... 82	350	120	Q65110A9131	35
	LE A Q9WN-JZKZ-1	● amber	617	61 ... 112	700	120	Q65111A1648	36
	LE T Q9WN-KZLZ-25	● true green	525	97 ... 180	700	120	Q65110A9134	36
	LE A Q9WP-KZLZ-1	● amber	617	97 ... 180	1400	120	Q65110A9145	34
	LE T Q9WP-MXNX-24	● true green	536	180 ... 330	1400	120	Q65110A9137	34
	LE CG Q9WP-6N5P-1	● converted green	0.318 / 0.642	315 ... 500	1400	130	Q65111A1356	34
	LE A Q6WP-MYNY-1	● amber	617	210 ... 390	1400	120	Q65111A2071	38
	LE CG Q6WP-5Q8Q-1	● converted green	0.318 / 0.642	710 ... 1120	1400	130	Q65111A2074	38









Industry Applications





Projection



OSRAM OSTAR Projection

Package	Type	Emission color	λ_{dom} (typ.)/ Cx/Cy [nm / -]	Φ_{E}	at φ	Viewing angle at 50 % I_{V} 2 φ typ. [°]	Ordering Code	Package Fig.
				[mW]	[mA]			

OSRAM OSTAR Projection Compact

	LE B Q9WP-3V7A-24	 blue	459	900 ... 1590	1400	120	Q65110A9144	34
	LE B Q9WM-4S3T-24	 blue	460	250 ... 400	350	120	Q65111A2345	35
	LE B Q9WN-2U2V-24	 blue	460	500 ... 900	700	120	Q65111A2386	36
	LE B Q6WP-5B5C-24	 blue	459	1800 ... 3150	1400	120	Q65111A2073	38



Package	Type	Emission color	λ_{dom} (typ.) [nm]	color 1 Φ_{V}	color 2 Φ_{V}	color 3 Φ_{E}	at φ	Viewing angle at 50 % I_{V} 2 φ typ. [°]	Ordering Code	Package Fig.
				[lm]	[lm]	[mW]				
	LE ATB N7WM-HYJX-1+JYKX-23+4S3T-CE	 amber  true green  blue	617 / 525 / 460	33 ... 52	52 ... 82	250 ... 400	350	120	Q65111A0733	56

Package	Type	Emission color	λ_{dom} (typ.) [nm]	color 1 Φ_{E}	color 2 Φ_{V}	at φ	Viewing angle at 50 % I_{V} 2 φ typ. [°]	Ordering Code	Package Fig.
				[mW]	[lm]				
	LE BA Q6WM-4S3T-CE+HYJY-23	 blue  amber	460 / 617	250 ... 400	33 ... 61	350	120	Q65111A1646	37

Industry Applications

Signs and Signals

OSLON SX







Package	Type	Emission color	λ_{dom} (typ.)/ Cx/Cy	at φ			Viewing angle at 50 % I_V 2 φ typ. [°]	Ordering Code	Package Fig.
				Φ_V	I_V typ.	[mA]			
			[nm / -]	[lm]	[cd]				
	LA CN5M-GAHA-24-1	 amber	617	18 ... 35.5	18.7	140	60	Q65111A1207	17
	LY CN5M-FAGA-36-1	 yellow	590	11.2 ... 22.4	11.8			Q65110A8680	
	LT CN5M-GAHB-25-1	 true green	528	18 ... 45	22.1	140	60	Q65110A9086	17
	LUW CN5M-GBHB-5P7R-1	 ultra white	0.32 / 0.31	22.4 ... 45	23.6	140	60	Q65111A3434	3

Package	Type	Emission color	λ_{dom} (typ.)/ Cx/Cy	at φ		Viewing angle at 50 % I_V 2 φ typ. [°]	Ordering Code	Package Fig.
				Φ_E	[mA]			
			[nm / -]	[mW]				
	LD CN5M-4Q4R-35-1	 deep blue	453	100 ... 180	140	60	Q65110A8683	17
	LD CN5M-1R1S-35-1			112 ... 201			Q65110A9085	

Industry Applications

Signs and Signals











OSLON Signal



Package	Type	Emission color	λ_{dom} (typ.)/ Cx/Cy [nm / -]	Φ_V	I_V typ.	at I_f	Viewing angle at 50 % I_V 2 ϕ typ. [°]	Ordering Code	Package Fig.
				[lm]	[cd]	[mA]			
	LV CK7P-JYKZ-25	 verde green	505	52 ... 112	48.6	350	80	Q65111A2323	39
	LB CL7P-HZJZ-3B6B	 blue	0.12 / 0.16	39 ... 71	32.6	350	80	Q65111A2433	39
	LA CP7P-JUKR-34	 amber	617	65.8 ... 89.2	43.1	350	80	Q65111A3124	39
	LY CP7P-JRJU-45	 yellow	590	52 ... 71	34.2	350	80	Q65111A3125	39

Industry Applications

Signs and Signals

OSLON Black

Package	Type	Emission color	λ_{dom} (typ.)/ Cx/Cy	at φ			Viewing angle at 50 % I_V 2 φ typ. [°]	Ordering Code	Package Fig.
				Φ_V	I_V typ.	[mA]			
			[nm / -]	[lm]	[cd]				
	LA H9GP-JYKY-24-1	 amber	617	52 ... 97	36.6	350	90	Q65111A1982	5
	LR H9GP-HZKX-1-1	 red	625	39 ... 82	29.7			Q65111A1707	
	LY H9GP-HZKX-36-1	 yellow	590					Q65111A1708	
	LS H9GP-HYJY-1-9B9C	 super red	633	33 ... 61	23.1			Q65111A2566	
	LB H9GP-GYHY-35-1	 blue	470	21 ... 39	15	350	90	Q65111A1710	5
	LT H9GP-JZKZ-26-1	 true green	528	61 ... 112	43.3			Q65111A1717	
	LUW H9GP-KYLY-4C8E-1	 ultra white	0.31 / 0.32	82 ... 150	55.7	350	90	Q65111A0924	5
	LUW H9GP-KYLY-5F8G-1							Q65111A0925	

Package	Type	Emission color	λ_{dom} (typ.)/ Cx/Cy	at φ		Viewing angle at 50 % I_V 2 φ typ. [°]	Ordering Code	Package Fig.
				Φ_E	[mA]			
			[nm / -]	[mW]				
	LD H9GP-3T2U-35-1	 deep blue	455	355 ... 560	350	90	Q65111A1709	5



Industry Applications



Signs and Signals

DRAGON

Package	Type	Emission color	λ_{dom} (typ.)/ Cx/Cy	Φ_V			Viewing angle at 50 % I_V 2 ϕ typ. [°]	Ordering Code	Package Fig.
				[nm / -]	[lm]	[cd]			

Golden DRAGON

	LB W5SM-FZHX-35	 blue	467	15 ... 33	7.9	350	120	Q65110A9221	6
	LT W5SM-JYKY-25	 true green	528	52 ... 97	24.6	350	120	Q65110A9212	6
	LT W5SM-JXKX-36			45 ... 82	21			Q65110A8417	

Package	Type	Emission color	λ_{dom} (typ.)/ Cx/Cy	Φ_E		Viewing angle at 50 % I_V 2 ϕ typ. [°]	Ordering Code	Package Fig.
				[nm / -]	[mW]			
	LD W5SM-4S4T-35	 deep blue	455	250 ... 450	350	120	Q65110A9216	6



Industry Applications

Signs and Signals

DRAGON

Package	Type	Emission color	λ_{dom} (typ.)/ Cx/Cy				Viewing angle at 50 % I_V 2 ϕ typ. [°]	Ordering Code	Package Fig.
				Φ_V	I_V typ.	at ϕ			
			[nm / -]	[lm]	[cd]	[mA]			

Platinum DRAGON



	LB W5SN-GZJX-35	● blue	470	24 ... 52	12.5	700	120	Q65110A7464	8
	LB W5SN-GYHZ-25			21 ... 45	10.9			Q65110A9222	
	LT W5SN-KYLY-25	● true green	528	82 ... 150	38.3	700	120	Q65110A9211	8
	LCW W5SN-KYLY-4L8N	○ warm white	0.42 / 0.4	82 ... 150	38.3	700	120	Q65110A7706	8
	LCW W5SN-KXLX-409Q			71 ... 130	33.2			Q65110A7708	
	LCW W5SN-KYLY-4J8K			82 ... 150	38.3			Q65110A7707	
	LCW W5SN-KXLX-4U9X			71 ... 130	33.2			Q65110A9713	
	LCW W5SN-KYLY-4R9T			82 ... 150	38.3			Q65110A9717	
	LV W5SN-KXLX-25	● verde green	505	71 ... 130	33.2	700	120	Q65111A0320	8

Package	Type	Emission color	λ_{dom} (typ.)/ Cx/Cy				Viewing angle at 50 % I_V 2 ϕ typ. [°]	Ordering Code	Package Fig.
				Φ_E	at ϕ				
			[nm / -]	[mW]	[mA]				
	LD W5SN-1U2V-35	● deep blue	455	450 ... 900	700	120	Q65111A0040	8	



Industry Applications

Signs and Signals

TOPLED

Package	Type	Emission color	λ_{dom} (typ.)/ Cx/Cy	at φ			Viewing angle at 50° % I_V 2 φ typ. [°]	Ordering Code	Package Fig.
				I_V	Φ_V typ.	[mA]			
			[nm / -]	[mcd]	[mlm]				
	LR T68F-U1AA-1-1	● red	625	450 ... 1400	2780	20	120	Q65110A7321	65
	LY T686-Q2T1-26	● yellow	587	90 ... 355	670	20	120	Q65110A2213	21
	LV T6SG-V1BB-25	● verde	505	710 ... 2800	5270	20	120	Q65111A1658	21

TOPLED Black

	LO T66F-AACA-24-1	● orange	606	1120 ... 3550	2335	20	55	Q65111A0147	57	
	LR T66F-AABB-1-1	● red	625	1120 ... 2800	1960			Q65111A1792		
	LY T66F-ABBB-46-1	● yellow	590	1400 ... 2800	2100			55		Q65110A8570
	LY T66F-AABA-35-1			1120 ... 2240	1680					Q65110A8569
	LB T66G-U1BA-59	● blue	470	450 ... 2240	1345	20	55	Q65111A0145	57	
	LT T66G-BBDA-29	● true green	528	2240 ... 5600	3920			Q65111A0146		

Package	Type	Emission color	λ_{dom} (typ.)/ Cx/Cy	at φ			Viewing angle at 50° % I_V 2 φ typ. [°]	Ordering Code	Package Fig.
				E_V	I_V typ.	[mA]			
			[nm / -]	[lux]	[mcd]				
	LO T64F-CBEB-24-1	● orange	606	3550 ... 11200	6040	20	30	Q65111A0265	40
	LR T64F-BBDB-1-1	● red	625	2240 ... 7100	3820			Q65111A0256	
	LY T64F-BBDA-35-1	● yellow	590	2240 ... 5600	3210			Q65111A0257	
	LY T64F-CADB-46-1			2800 ... 7100	4050			Q65111A0258	
	LB T64G-V1CA-59	● blue	470	710 ... 3550	1740	20	30	Q65111A0143	40
	LT T64G-DAFA-29	● true green	528	4500 ... 14000	7580			Q65111A0144	
LV T64G-BBEA-25	● verde	505	2240 ... 9000	4590	Q65111A2028				

Industry Applications

Signs and Signals

MULTILED

Package	Type	Emission color	λ_{dom} (typ.) [nm]	I_V [mcd]			at φ [mA]	Viewing angle at 50 % I_V 2 φ typ. [°]	Ordering Code	Package Fig.
				color 1	color 2	color 3				
	LRTBGFUG-S5T9-1+U7V5-29+R5S7-49	<ul style="list-style-type: none"> ● red ● true green ● blue 	625 / 528 / 470	201 ... 630	560 ... 1250	125 ... 355	20	120	Q65111A3098	41
	LRTBGFTG-T7AW-1+V7A7-29+R5T9-49	<ul style="list-style-type: none"> ● red ● true green ● blue 	625 / 528 / 470	355 ... 1800	900 ... 2240	125 ... 630	20	120	Q65110A8177	42
	LRTBGFTM-ST7-1+V9-29+Q5R7-49	<ul style="list-style-type: none"> ● red ● true green ● blue 	625 / 528 / 470	180 ... 560	710 ... 1590	80 ... 224	10	120	Q65110A9407	42

Package	Type	Emission color	λ_{dom} (typ.) [nm]	I_V [mcd]		at φ [mA]	Viewing angle at 50 % I_V 2 φ typ. [°]	Ordering Code	Package Fig.
				color 1	color 2				
	LRT GFTM-ST7-1+V9-29	<ul style="list-style-type: none"> ● red ● true green 	625 / 528	180 ... 560	710 ... 1590	10	120	Q65111A0439	58

Multi CERAMOS

Package	Type	Emission color	λ_{dom} (typ.) [nm]	I_V [mcd]			at φ [mA]	Viewing angle at 50 % I_V 2 φ typ. [°]	Ordering Code	Package Fig.
				color 1	color 2	color 3				
	LRTBC9TP-CWD5-1+D5E7-25+A7CW-49	<ul style="list-style-type: none"> ● red ● true green ● blue 	625 / 528 / 470	2800 ... 8000	5000 ... 14000	1400 ... 4500	140	120	Q65111A2182	32

Industry Applications

Signs and Signals

Multi CHIPLED

Package	Type	Emission color	λ_{dom} (typ.) [nm]	I_V [mcd]				Viewing angle at 50 % I_V 2 ϕ typ. [°]	Ordering Code	Package Fig.
				color 1	color 2	color 3	at ϕ [mA]			
	LRTBR98G-R5T-1+S7T7-35+PQ-47	<ul style="list-style-type: none"> ● red ● true green ● blue 	625 / 503 / 470	125 ... 450	224 ... 710	56 ... 180	20	120	Q65111A3103	43

OSRAM OSTAR SMT

Package	Type	Emission color	Color coordinates Cx/Cy typ.	Φ_V [lm]	at ϕ [mA]	Viewing angle at 50 % I_V 2 ϕ typ. [°]	Ordering Code	Package Fig.

Package	Type	Emission color	λ_{dom} (typ.) [nm]	Φ_V			at ϕ [mA]	Viewing angle at 50 % I_V 2 ϕ typ. [°]	Ordering Code	Package Fig.
				color 1 Φ_V [mlm]	color 2 Φ_V [mlm]	color 3 Φ_E [mW]				
	LE ATB S2W-JWKW-1+MANA-25+2U2V-24	<ul style="list-style-type: none"> ● amber ● true green ● blue 	617 / 529 / 464	45 ... 112	180 ... 355	500 ... 900	700	120	Q65111A2488	44

OSRAM OSTAR Stage



Package	Type	Emission color	λ_{dom} (typ.)/ Cx/Cy [nm / -]	Φ_V				at ϕ [mA]	Viewing angle at 50 % I_V 2 ϕ typ. [°]	Ordering Code	Package Fig.
				color 1 Φ_V [lm]	color 2 Φ_V [lm]	color 3 Φ_E [mW]	color 4 Φ_V [lm]				
	LE RTDUW S2W	<ul style="list-style-type: none"> ● red ● true green ● deep blue ○ ultra white 	625 / 527 / 453 / 0.31 / 0.32	45 ... 112	90 ... 180	560 ... 900	140 ... 224	700	120	Q65111A0884	44

Industry Applications

Electronic Equipment

Advanced Power TOPLED Plus

Package	Type	Emission color	λ_{dom} (typ.)/ Cx/Cy				Viewing angle at 50 % I_V 2 ϕ typ. [°]	Ordering Code	Package Fig.
				Φ_V	I_V typ.	at ϕ			
			[nm / -]	[lm]	[cd]	[mA]			
	LUW G5GP-GXHY-5C8E	○ ultra white	0.31 / 0.32	18 ... 39	7.4	100	135	Q65110A9093	59
	LUW G5GP-GXHY-5F8G							Q65110A9091	

Package	Type	Emission color	λ_{dom} (typ.)/ Cx/Cy				Viewing angle at 50 % I_V 2 ϕ typ. [°]	Ordering Code	Package Fig.
				I_V	Φ_V typ.	at ϕ			
			[nm / -]	[mcd]	[mlm]	[mA]			
	LA G5AP-CZDZ-24-1	● amber	617	3900 ... 7100	24200	100	145	Q65111A1021	59
	LMW G5AP-7C8D-NZN6-DF-LH	○ multiphosphor white	0.26 / 0.22	3550 ... 7100	23400	100	135	Q65110A9418	59
	LUW G5AP-5D5E-BG-P4P6-LH	○ ultra white	0.25 / 0.2	4500 ... 8000	27500	100	135	Q65110A9419	59

Industry Applications

Electronic Equipment

Power TOPLED





Package	Type	Emission color	λ_{dom} (typ.)/ Cx/Cy	at φ			Viewing angle at 50° % I_v 2 φ typ. [°]	Ordering Code	Package Fig.			
				I_v [mcd]	Φ_v typ. [mlm]	[mA]						
	LA E67F-BACA-24-3A4B	● amber	617	1800 ... 3550	8000	50	120	Q65110A9090	11			
	LA E67F-BACA-24-3B5A							Q65110A9089				
	LY E67F-AABA-35-1	● yellow	590	1120 ... 2240	5000			Q65110A9019				
	LY E67F-ABBB-46-1			1400 ... 2800	6300			Q65110A9018				
	LS E67F-ABBB-1-1	● super red	633					Q65111A1118				
	LO E67F-BADA-24-1	● orange	606	1800 ... 5600	11100			Q65111A0963				
	LR E67F-ABCA-1-1	● red	625	1400 ... 3550	7400			Q65111A2785				
	LR E6SF-ABCA-1-1	● red	625	1400 ... 3550	7430	50	120	Q65111A0958	11			
	LA E6SF-BBCB-24-1	● amber	617	2240 ... 4500	10110			Q65110A6262				
	LO E6SF-ABCB-24-1	● orange	606	1400 ... 4500	8850			Q65110A7524				
	LY E6SF-V2AB-35-1	● yellow	590	900 ... 1800	4050			Q65110A7525				
	LY E6SF-AABA-46-1			1120 ... 2240	5040			Q65110A6209				
	LA ETSF-BACB-24-1	● amber	617	1800 ... 4500	9500	50	120	Q65110A9777	11			
	LY ETSF-AABA-35-1	● yellow	590	1120 ... 2240	5000			Q65110A9778				
	LB E6SG-T1U2-35	● blue	470	280 ... 710	1485	30	120	Q65110A7883	12			
	LT E6SG-AABB-35-1	● true green	525	1120 ... 2800	5880			Q65111A0322				
	LCB E6SG-AABB-2J8L	● color on demand blue	0.2 / 0.3	1120 ... 2800	5880	30	120	on request	12			
	LCW E6SG-V1AB-4R9T			710 ... 1800	3765			Q65110A7737				
	LCW E6SG-V1AB-4U9X							Q65110A7736				
	LCW E6SG-V2BA-4L8N	○ warm white	0.42 / 0.4					30		120	Q65110A7734	12
	LCW E6SG-V2BA-4J8K			900 ... 2240	4710			Q65110A7735				
	LCW E6SG-V2BA-4O9Q							Q65110A7733				
	LP E675-P2R1-25	● pure green	560	56 ... 140	294	50	120	Q65110A7298	18			
	LW E6SG-AABA-JKPL-1	○ white	0.33 / 0.33	1120 ... 2800	5900	30	120	Q65111A0196	12			
	LW E6SG-AABA-JKPL-1	○ white	0.33 / 0.33	1120 ... 2240	5000			Q65110A8964		12		

Industry Applications

Electronic Equipment

Power TOPLED

Package	Type	Emission color	λ_{dom} (typ.)/ Cx/Cy	E_v			Viewing angle at 50° % I_v 2 ϕ typ.	Ordering Code	Package Fig.
				[nm / -]	[lux]	[mlm]			
	LA E63F-EBGA-24-3A4B	 amber	617	9000 ... 22400	6300	50	30	Q65110A4103	13
	LS E63F-DBFA-1	 super red	633	5600 ... 14000	3900			Q65110A4105	
	LY E63F-DBEB-35-1	 yellow	590	5600 ... 11200	3400			Q65110A4108	
	LY E63F-EAFA-46-1		7100 ... 14000	4200	Q65110A4107				
	LB E63C-T2V2-35-34	 blue	469	355 ... 1120	400	30	20	Q65110A1974	20
	LT E63C-BADB-35-1	 true green	525	1800 ... 7100	2700			Q65110A1981	

Package	Type	Emission color	λ_{dom} (typ.)/ Cx/Cy	I_v			Viewing angle at 50° % I_v 2 ϕ typ.	Ordering Code	Package Fig.
				[nm / -]	[mcd]	Φ_v typ. [mlm]			
	LS E65F-BBDA-1	 super red	633	2240 ... 5600	4500	50	60	Q65110A4106	14
	LA E65F-CBEA-24-3A4B	 amber	617	3550 ... 9000	7200			Q65110A4104	
	LY E65F-CBDB-35	 yellow	590	3550 ... 7100	6100			Q65110A6456	
	LY E65F-DAEB-46-1		4500 ... 11200	8900	Q65111A1412				

Industry Applications

Electronic Equipment







TOPLED

Package	Type	Emission color	λ_{dom} (typ.)/ Cx/Cy	at φ			Viewing angle at 50° % I_V 2 φ typ. [°]	Ordering Code	Package Fig.
				I_V [mcd]	Φ_V typ. [mlm]	[mA]			
	LS T676-P2S1-1	● super red	633	56 ... 224	420	20	120	Q65110A2153	21
	LO T676-Q2T1-24	● orange	606	90 ... 355	670			Q65110A2150	
	LY T676-Q2T1-26	● yellow	587					Q65110A2156	
	LA T676-Q2T1-24	● amber	615					Q65110A9273	
	LS T67F-T2V2-1-1	● super red	633	355 ... 900	1880	20	120	Q65110A9233	21
	LR T67F-U1AA-1-1	● red	625	450 ... 1400	2780			Q65110A9232	
	LA T67F-U2AB-24-1	● amber	617	560 ... 1800	3540			Q65110A9268	
	LY T67F-U1AA-36-1	● yellow	590	450 ... 1400	2780			Q65110A9231	
	LP T67F-N1Q2-24	● pure green	560	28 ... 112	210			Q65111A1851	
	LP T67F-P1R2-35	● green		45 ... 180	340			Q65111A1852	
	LG T67F-R1T1-24	● green	570	112 ... 355	700			Q65111A1826	
	LB T673-L2P1-25	● blue	471	14 ... 56	105	10	120	Q65111A1007	21
	LT T673-N2S1-25	● true green	529	35.5 ... 224	390			Q65110A1968	
	LT T673-L2N2-35			14 ... 45	90			2	
	LCB T67S-P2R2-2J8L	● color on demand blue	0.2 / 0.3	56 ... 180	355	10	120	Q65111A2936	21
	LG T676-P1Q2-24	● green	570	45 ... 112	240	20	120	Q65110A2178	21
	LP T676-L1M2-25	● pure green	560	11.2 ... 28	60	20	120	Q65110A2179	21
	LG T67K-G2K1-24	● green	570	2.24 ... 9	16.86	2	120	Q65110A2184	21
	LP T67K-E1F2-25	● pure green	560	0.71 ... 1.8	3.765	2	120	Q65110A2185	21
	LP T67K-F1G2-25			1.12 ... 2.8	5.88			Q65110A2186	
LP T67K-E1G2-25	0.71 ... 2.8			5.265	Q65110A2187				
	LH T674-L2P1-1	● hyper red	645	14 ... 56	105	10	120	Q65110A3596	21
	LW T673-P1S1-FKPL	○ white	0.33 / 0.33	45 ... 224	400	10	120	Q65111A2043	21
	LW T6SG-V2BA-JKPL	○ white	0.33 / 0.33	900 ... 2240	4710	20	120	Q65110A8982	52
	LW T6SG-V1AA-JKPL			710 ... 1400	3165			Q65110A8981	

Industry Applications

Electronic Equipment

TOPLED

Package	Type	Emission color	λ_{dom} (typ.)/ Cx/Cy	at I_f			Viewing angle at 50 % I_V 2ϕ typ. [°]	Ordering Code	Package Fig.
				I_V	Φ_V typ.	[mA]			
			[nm / -]	[mcd]	[mlm]				
	LA T67D-U2AA-24-1	 amber	617	560 ... 1400	2940	20	120	Q65110A9889	21
	LO T67D-U2AA-24-1	 orange	606					Q65110A9919	
	LR T67D-U1V2-1-1	 red	625	450 ... 1120	2360			Q65110A9920	
	LS T67D-T2V1-1-1	 super red	633	355 ... 900	1880			Q65110A9896	
	LY T67D-U1V2-36-1	 yellow	590	450 ... 1120	2360			Q65110A9898	

Industry Applications

Electronic Equipment

































SIDELED

Package	Type	Emission color	λ_{dom} (typ.)/ Cx/Cy	at φ			Viewing angle at 50° % I_V 2 φ typ. [°]	Ordering Code	Package Fig.
				I_V [mcd]	Φ_V typ. [mlm]	[mA]			
	LB A673-L2P1-35	 blue	470	14 ... 56	105	10	120	Q65110A1950	22
	LT A673-N2S1-25	 true green	529	35.5 ... 224	390			Q65110A1962	
	LT A6SG-V1AB-36	 true green	528	710 ... 1800	3765	20	120	Q65110A6030	53
	LT A6SG-V2AB-35			900 ... 1800	4050			Q65110A7884	
	LCB A6SG-U2AB	 color on demand blue	0.2 / 0.3	1800 ... 560	3540	20	120	on request	53
	LG A676-P1Q2-24	 green	570	45 ... 112	235	20	120	Q65110A2285	22
	LP A676-L1M2-25	 pure green	560	11.2 ... 28	60	20	120	Q65110A2286	22
	LG A67K-G2K1-24	 green	570	2.24 ... 9	15	2	120	Q65110A2291	22
	LP A67K-E1G2-25	 pure green	560	0.71 ... 2.8	5	2	120	Q65110A2294	22
	L0 A67K-K1M2-24	 orange	606	7.1 ... 28	55	2	120	Q65110A4969	22
	LS A67K-J1L2-1	 super red	630	4.5 ... 18	35			Q65110A2018	
	LY A67K-J2M1-26	 yellow	587	5.6 ... 22.4	40			Q65110A2067	
	LP A675-N1P2-25	 pure green	560	28 ... 71	150	30	120	Q65110A2310	22
	LS A67F-U1AA-1	 super red	633	450 ... 1400	2780	30	120	Q65110A4723	22
	LR A67F-U2AB-1	 red	625	560 ... 1800	3540			Q65110A4729	
	LA A67F-AABB-24-1	 amber	617	1120 ... 2800	5880			Q65111A0513	
	L0 A67F-V2BB-24	 orange	606	900 ... 2800	5550			Q65110A4867	
	LY A67F-U2AB-36	 yellow		560 ... 1800	3540			Q65110A4722	
	LS A676-P2S1-1	 super red	633	56 ... 224	420			Q65110A2261	
LA A676-Q2T1-1	 amber	615	90 ... 355	670	20	120	Q65110A2255	22	
L0 A676-Q2T1-24	 orange	606					Q65110A2258		
LY A676-Q2T1-26	 yellow	587					Q65110A2264		

Industry Applications

Electronic Equipment

Mini TOPLED

Package	Type	Emission color	λ_{dom} (typ.)/ Cx/Cy	at φ			Viewing angle at 50° % I_V 2 φ typ. [°]	Ordering Code	Package Fig.
				I_V [mcd]	Φ_V typ. [mlm]	[mA]			
	LB M673-L1N2-25	 blue	471	11.2 ... 45	80	10	120	Q65111A1010	23
	LT M673-N1R2-25	 true green	529	28 ... 180	310			Q65110A5930	
	LS M676-P2S1-1	 super red	633	56 ... 224	420	20	120	Q65110A2364	23
	LA M676-Q2T1-1	 amber	615	90 ... 355	670			Q65110A2358	
	LO M676-Q2T1-24	 orange	606					Q65110A2361	
	LY M676-Q2T1-26	 yellow	587	Q65110A2367					
	LG M676-N2Q1-24	 green	570	35.5 ... 90	190			Q65110A2389	
	LP M676-L1M2-25	 pure green	560	11.2 ... 28	60			Q65110A7809	
	LCB M67S-K2M1-2J8L	 color on demand blue	0.2 / 0.3	9 ... 22.4	40	2	120	Q65111A2807	23
	LG M676-N2Q1-24	 green	570	35.5 ... 90	190	20	120	Q65110A2389	23
	LP M676-L1M2-25	 pure green	560	11.2 ... 28	60	20	120	Q65110A7809	23
	LG M67K-G1J2-24	 green	570	1.8 ... 7.1	13.4	2	120	Q65110A2395	23
	LP M67K-D2G1-25	 pure green	560	0.56 ... 2.24	4.2	2	120	Q65110A2398	23
	LS M67K-H2L1-1	 super red	630	3.55 ... 14	25	2	120	Q65110A2028	23
	LO M67K-J2M1-24	 orange	606	5.6 ... 22.4	42			Q65110A2055	
	LY M67K-J1L2-26	 yellow	587	4.5 ... 18	33.8			Q65110A2076	
	LG M67K-G1J2-24	 green	570	1.8 ... 7.1	13.4			Q65110A2395	
	LP M67K-D2G1-25	 pure green	560	0.56 ... 2.24	4.2			Q65110A2398	
	LP M675-M2P1-25	 pure green	560	22.4 ... 56	120			30	
	LO M67F-U2AB-24	 orange	606	560 ... 1800	3540	20	120	Q65110A8973	23
	LS M67F-S2U2-1	 super red	633	224 ... 710	1400			Q65110A8888	
LY M67F-T2V2-36	 yellow	590	355 ... 1120	2210	Q65110A8980				
LA M67F-V1AB-24	 amber	617	710 ... 1800	3770	Q65111A1848				
	LW M673-P1R2-FKPL	 white	0.33 / 0.33	45 ... 180	340	10	120	Q65111A2039	23
	LW M67C-S1T2-5K8L	 white	0.33 / 0.33	180 ... 450	950	20	120	Q65110A1936	23
	LW M67C-T1U2-5K8L			280 ... 710	1490			Q65110A1937	
	LW M67C-S1U2-5K8L			180 ... 710	1340			Q65110A1938	
	LCW MTSG-U2V2-4L8N	 warm white	0.38 / 0.38	560 ... 1120	2520	10	120	Q65111A2101	28



Industry Applications

Electronic Equipment





CHIPLED

Package	Type	Emission color	λ_{dom} (typ.)/ Cx/Cy	Viewing angle at 50°			Viewing angle at 50° % I_V 2 ϕ typ. [°]	Ordering Code	Package Fig.
				I_V [mcd]	Φ_V typ. [mlm]	at I_f [mA]			













CHIPLED 1206

	LH N974-KN-1	 hyper red	645	7.1 ... 45	15	20	160	Q62702P5192	60
---	--------------	---	-----	------------	----	----	-----	-------------	----







CHIPLED 0805

	LS R976-NR-1	 super red	633	28 ... 180	330	20	160	Q62702P5178	46
	LO R976-PS-1	 orange	606	45 ... 280	520			Q62702P5101	
	LY R976-PS-36	 yellow	588					Q62702P5177	

CHIPLED 0603

	LS Q971-KN-1	 super red	628	7.1 ... 45	60	20	160	Q65110A4282	61
	LO Q971-JM-1	 orange	606	4.5 ... 28	40			Q65110A4285	
	LY Q971-H1L2-36	 yellow	587	2.8 ... 18	20			Q62703Q4699	
	LG Q971-KN-1	 green	570	7.1 ... 45	60			Q62702P5189	
	LS Q976-NR-1	 super red	633	28 ... 180	330	20	160	Q62702P5187	47
	LO Q976-PS-25	 orange	605	45 ... 280	520			Q62702P5188	
	LY Q976-P1S2-36	 yellow	587					Q62702P5276	
	LG Q976-MP-24	 green	572	18 ... 71	130			Q65110A8842	
	LT Q39E-Q1S2-25-1	 true green	530	71 ... 280	440	5	155 (horizontal) 135 (vertical)	Q65110A7998	48













CHIPLED 0402

	LB QH9G-N1P2-35-1	 blue	466	28 ... 71	150	5	155 (horizontal) 170 (vertical)	Q65110A8032	49
	LT QH9G-Q2S2-25-1	 true green	525	90 ... 280	560			Q65110A9219	
	LR QH9F-P2R1-1	 red	625	56 ... 140	290	5	120 (horizontal) 130 (vertical)	Q65110A8031	49
	LY QH9F-P1R1-36	 yellow	590	45 ... 140	280			Q65110A8028	



Industry Applications

Electronic Equipment

SMARTLED

Package	Type	Emission color	λ_{dom} (typ.)/ Cx/Cy	at φ			Viewing angle at 50° % I_V 2 φ typ. [°]	Ordering Code	Package Fig.
				I_V [mcd]	Φ_V typ. [mlm]	[mA]			
	LG L29K-F2J1-24	 green	570	1.4 ... 5.6	14	2	160	Q65110A1745	25
	LS L29K-G1J2-1	 super red	630	1.8 ... 7.1	18			Q65110A1757	
	LO L29K-H2L1-24	 orange	606	3.55 ... 14	35			Q65110A1751	
	LY L29K-H1K2-26	 yellow	587	2.8 ... 11.2	28			Q65110A1766	
	LS L296-N1Q2-1	 super red	633	28 ... 112	280	20	160	Q65110A1754	25
	LA L296-P1R2	 amber	615	45 ... 180	450			Q65110A3235	
	LO L296-P1S1-24	 orange	606	45 ... 224	538			Q65110A1905	
	LY L296-P1R2-26	 yellow	587	45 ... 180	450			Q65110A1764	
	LP L296-J2L2-25	 pure green	560	5.6 ... 18	35			Q65110A3342	
	LW L283-P2R1-3K8L-1	 white	0.32 / 0.31	56 ... 140	392	10	170 (horizontal) 130 (vertical)	Q65110A1550	25
	LW L283-Q1R2-3K8L-1			71 ... 180	502			Q65110A1647	





















SMARTLED XR

	LS L196-N1R2-1	 super red	633	28 ... 180	430	20	150	Q65111A0708	26
	LY L196-P1S1-26	 yellow	587	45 ... 224	555			Q65111A0703	

Industry Applications

Electronic Equipment









PointLED

Package	Type	Emission color	λ_{dom} (typ.)/ Cx/Cy	at φ			Viewing angle at 50° % I_V 2 φ typ. [°]	Ordering Code	Package Fig.
				I_V [mcd]	Φ_V typ. [mlm]	[mA]			
	LS P47F-U1AA-1-1	 super red	633	450 ... 1400	2780	30	120	Q65110A4859	27
	LR P47F-U2AB-1-1	 red	625	560 ... 1800	3540			Q65110A4861	
	LA P47F-V2BB-24-3A4B	 amber	617	900 ... 2800	5550			Q65110A4857	
	LA P47F-V2BB-24-3B5A		Q65110A9267						
	LY P47F-U2AB-36-4A5B	 yellow	590	560 ... 1800	3540			Q65110A9266	
	LY P47F-U2AB-36-3B5A		Q65110A4860						
	LP P47F-P2S1-35	 pure green	560	56 ... 224	420			Q65111A1828	
	LP P47F-P1R1-24		45 ... 140	280	Q65111A1827				
	LB P4SG-S2U1-35-1	 blue	470	224 ... 560	1180	20	120	Q65110A8252	27
	LT P4SG-V1AB-36-1	 true green	528	710 ... 1800	3770			Q65110A7127	
	LCB P473-P2R2	 color on demand blue	0.2 / 0.3	180 ... 56	350	10	120	on request	54
	LG P47K-G2K1-24	 green	570	2.24 ... 9	17	2	120	Q65110A2730	54
	LO P476-R2T1-24	 orange	606	140 ... 355	740	20	120	Q65110A7018	54
	LY P476-Q2T1-26	 yellow	587	90 ... 355	670	20	120	Q65110A4881	54
	LS P47K-H1K2-1	 super red	630	2.8 ... 11.2	21	2	120	Q65110A2733	54
	LY P47K-J1L2-26	 yellow	587	4.5 ... 18	34			Q65110A2738	
	LW P473-Q2S1-FKPL-1	 white	0.33 / 0.33	90 ... 224	470	10	120	Q65111A2066	54
	LW P4SG-V2AB-JKPL-1	 white	0.33 / 0.33	900 ... 1800	4050	20	120	Q65110A9047	27
	LW P4SG-V2AB-JKPL-1-F							Q65110A9048	













Industry Applications

Electronic Equipment

FIREFLY

Package	Type	Emission color	λ_{dom} (typ.)/ Cx/Cy	at φ			Viewing angle at 50% I_V 2 φ typ. [°]	Ordering Code	Package Fig.
				I_V	Φ_V typ.	[mA]			
			[nm / -]	[mcd]	[mlm]				
	LT VH9G-Q2S2-25-1	 true green	532	90 ... 280	560	5	140 (horizontal) 165 (vertical)	Q65110A9228	31
	LB VH9G-N1P2-35-1	 blue	470	28 ... 71	150			Q65110A8083	
	LW VH8G-Q2S2-4M6N-1	 white	0.285 / 0.275	90 ... 280	560	5	140 (horizontal) 180 (vertical)	Q65110A8090	31
	LA VH9F-Q1R2-24	 amber	615	71 ... 180	380	5	140 (horizontal) 165 (vertical)	Q65110A8082	31
	LR VH9F-P2R1-1	 red	625	56 ... 140	290			Q65110A8088	



Micro SIDELED











Package	Type	Emission color	λ_{dom} (typ.)/ Cx/Cy	at φ			Viewing angle at 50% I_V 2 φ typ. [°]	Ordering Code	Package Fig.
				I_V	Φ_V typ.	[mA]			
			[nm / -]	[mcd]	[mlm]				
	LS Y876-P2S1-1	 super red	633	56 ... 224	420	20	120	Q65110A2412	29
	LO Y876-Q2T1-24	 orange	606	90 ... 355	670			Q65110A2410	
	LY Y876-Q2T1-26	 yellow	587					Q65110A2415	
	LG Y876-P1Q2-24	 green	570	45 ... 112	240			Q65110A8025	
	LW Y8SG-V1AA-3K6L	 white	0.3 / 0.28	710 ... 1400	3170	20	120	Q65110A7980	29
	LB Y8SG-T1U2-35-1	 blue	470	280 ... 710	1490	20	120	Q65110A8976	29
	LT Y8SG-V1AB-36-1	 true green	528	710 ... 1800	3770			Q65110A8975	
	LR Y8SF-U1V2-1	 red	625	450 ... 1120	2400			20	
LY Y8SF-U1V2-36	 yellow	590	Q65110A8977						



Industry Applications



Electronic Equipment

MULTILED

Package	Type	Emission color	λ_{dom} (typ.)/ Cx/Cy	I_v			Viewing angle at 50 % I_v 2 ϕ typ. [°]	Ordering Code	Package Fig.
				[nm / -]	[mcd]	Φ_v typ. [mlm]			
	LYYG6SF-CADB-45	 yellow	587	2800 ... 7100	14850	50	120	Q65110A8529	15

Package	Type	Emission color	λ_{dom} (typ.)	I_v [mcd]			at ϕ [mA]	Viewing angle at 50 % I_v 2 ϕ typ. [°]	Ordering Code	Package Fig.
				[nm]	color 1	color 2				
	LRTBGFUG-S5T9-1+U7V5-29+R5S7-49	 red  true green  blue	625 / 528 / 470	201 ... 630	560 ... 1250	125 ... 355	20	120	Q65111A3098	41
	LRTBGFUG-T7AW-1+V7A7-29+R5T9-49	 red  true green  blue	625 / 528 / 470	355 ... 1800	900 ... 2240	125 ... 630	20	120	Q65110A8177	42
	LRTBGFUM-ST7-1+VW9-29+Q5R7-49	 red  true green  blue	625 / 528 / 470	180 ... 560	710 ... 1590	80 ... 224	10	120	Q65110A9407	42





Package	Type	Emission color	Cx/Cy	I_v		Viewing angle at 50 % I_v 2 ϕ typ. [°]	Ordering Code	Package Fig.
				[mcd]	at ϕ [mA]			
	LTRBGFSG-ABCB-QKY0	 white	0.31 / 0.31	1400 ... 4500	20 (T) 20 (R) 10 (B)	120	Q65110A9484	42

Package	Type	Emission color	λ_{dom} (typ.)	I_v [mcd]		at ϕ [mA]	Viewing angle at 50 % I_v 2 ϕ typ. [°]	Ordering Code	Package Fig.
				[nm]	color 1				
	LRT GFTM-ST7-1+VW9-29	 red  true green	625 / 528	180 ... 560	710 ... 1590	10	120	Q65111A0439	58

Industry Applications

Electronic Equipment

Multi TOPLED

Package	Type	Emission color	λ_{dom} (typ.) [nm]	I_V [mcd]			Viewing angle at 50 % I_V 2 ϕ typ. [°]	Ordering Code	Package Fig.
				color 1	color 2	at ϕ [mA]			
	LAY T67F-AABB-1-1+AABA-45-1	● amber ● yellow	617 / 590	1120 ... 2800	1120 ... 2240	50	120	Q65110A7526	16
	LOG T77K-JL-1-0+GJ-1	● orange ● green	606 / 570	4.5 ... 18	1.8 ... 7.1	2	120	Q65110A3338	51
	LSY T676-P2R1-1-0+Q2S1-35	● super red ● yellow	633 / 587	56 ... 140	90 ... 224	20	120	Q65110A2446	16
	LSG T676-P7Q7-1+N7P7-24	● super red ● green	633 / 570	56 ... 140	35.5 ... 90	20	120	Q65110A4186	16
	LSG T676-P7R-1-0+N7P9-24			56 ... 180	35.5 ... 100			Q65111A1615	
	LSG T77K-JL-1-0+HK-1-0	● super red ● green	630 / 570	4.5 ... 18	2.8 ... 11.2	2	120	Q65111A0238	51

Multi CHIPLED

Package	Type	Emission color	Cx/Cy	I_V at ϕ		Viewing angle at 50 % I_V 2 ϕ typ. [°]	Ordering Code	Package Fig.
				[mcd]	[mA]			
	LTRBR8SF-8A7B-0117	○ white	0.267 / 0.231	1590 ... 2500	25 (T) 17 (R) 15 (B)	130	Q65111A2354	62

TOPLED Compact

Package	Type	Emission color	λ_{dom} (typ.)/ Cx/Cy [nm / -]	I_V at ϕ			Viewing angle at 50 % I_V 2 ϕ typ. [°]	Ordering Code	Package Fig.
				[mcd]	Φ_V typ. [mlm]	[mA]			
	LUW JLSH-5B8B-I4Q7-EG-LP	○ ultra white	0.29 / 0.27	1800 ... 2800	7360	20	110	Q65111A1048	63

Industry Applications

White Goods





DRAGON

Package	Type	Emission color	λ_{dom} (typ.)/ Cx/Cy	at φ			Viewing angle at 50° % I_V 2 φ typ. [°]	Ordering Code	Package Fig.
				Φ_V	I_V typ.				
			[nm / -]	[lm]	[cd]	[mA]			

Golden DRAGON

	LCW W5SM-JXKY-409Q	○ warm white	0.42 / 0.4	45 ... 97	23.4	350	120	Q65110A9681	7
	LCW W5SM-JXXK-4U9X			45 ... 82	21			Q65110A9692	
	LCW W5SM-JYKY-4L8N			52 ... 97	24.6			Q65110A9694	
	LCW W5SM-JYKY-4R9T							Q65110A9693	
	LCW W5SM-JYKZ-4J8K			52 ... 112	27.1			Q65110A9698	

TOPLED

Package	Type	Emission color	λ_{dom} (typ.)/ Cx/Cy	at φ			Viewing angle at 50° % I_V 2 φ typ. [°]	Ordering Code	Package Fig.
				I_V	Φ_V typ.				
			[nm / -]	[mcd]	[mlm]	[mA]			
	LW TTSD-U1V1-JKPL-1	○ white	0.33 / 0.33	450 ... 900	2030	20	120	Q65111A0300	52
	LW TTSD-U2V2-JKPL-1			560 ... 1120	2520			Q65111A0301	
	LB TTSD-R1T2-25-1	● blue	469	112 ... 450	810	20	120	Q65111A1639	52
	LCB TTSD-T2V1-2J8L	● color on demand blue	0.2 / 0.3	355 ... 900	1880	10	120	Q65111A1160	52
	LT TTSD-T2V2-36-1	● true green	525	355 ... 1120	2140	10	120	Q65111A2711	52
	LW TVSG.BB-AZBZ-FBKC-1	○ white	0.33 / 0.34	1500 ... 2800	6500	20	120	Q65111A2884	24
	LW TVSG.BB-BXCX-LBNC-1			1800 ... 3300	7700			Q65111A2473	
	LW TVSG.CB-AZBZ-JKPL-1	○ white	0.33 / 0.33	1500 ... 2800	6450	20	120	Q65111A2760	24
	LW TVSG.CB-BXCX-JKPL-1			1800 ... 3300	7650			Q65111A3555	

Industry Applications

White Goods





SIDELED

Package	Type	Emission color	λ_{dom} (typ.)/ Cx/Cy	at ϕ			Viewing angle at 50 % I_V 2 ϕ typ. [°]	Ordering Code	Package Fig.
				I_V	Φ_V typ.	[mA]			
			[nm / -]	[mcd]	[mlm]				
	LW A673-P1S1-FKPL	○ white	0.33 / 0.33	45 ... 224	400	10	120	Q65111A2075	22
	LW A67C-T2U2-5K8L	○ white	0.33 / 0.33	355 ... 710	1600	20	120	Q65110A1928	22
	LW A67C-S2U2-5K8L			224 ... 710	1400			Q65110A1929	
	LW A6SG-V2BA-JKPL	○ white	0.33 / 0.33	900 ... 2240	4710	20	120	Q65110A8994	53

CHIPLED

Package	Type	Emission color	λ_{dom} (typ.)/ Cx/Cy	at ϕ			Viewing angle at 50 % I_V 2 ϕ typ. [°]	Ordering Code	Package Fig.
				I_V	Φ_V typ.	[mA]			
			[nm / -]	[mcd]	[mlm]				

CHIPLED 0603

	LG Q971-KN-1	● green	570	7.1 ... 45	60	20	160	Q62702P5189	61
	LS Q976-NR-1	● super red	633	28 ... 180	330	20	160	Q62702P5187	47
	LW Q38E-Q1S2-3K6L-1	○ white	0.3 / 0.28	71 ... 280	530	5	150 (horizontal) 130 (vertical)	Q65110A7210	48
	LW Q38E-Q2R2-3K5L			90 ... 180	410			Q65110A7939	
	LW Q38G-Q1S1-3K6L-1	○ white	0.3 / 0.28	71 ... 224	440	5	150 (horizontal) 130 (vertical)	Q65110A7209	48
	LW Q38G-Q2R2-3K5L-1			90 ... 180	410			Q65110A7584	
	LB Q39E-L2N2-35-1	● blue	470	14 ... 45	70	5	155 (horizontal) 135 (vertical)	Q65110A7212	48
	LB Q39E-N1P1-35-1			28 ... 56	110			Q65110A7941	
	LG Q976-MP-24	● green	572	18 ... 71	130	20	130	Q65110A8842	47

White Goods

Micro SIDELED

Package	Type	Emission color	λ_{dom} (typ.)/ Cx/Cy	at φ			Viewing angle at 50 % I_v 2 φ typ. [°]	Ordering Code	Package Fig.
				I_v	Φ_v typ.	[mA]			
			[nm / -]	[mcd]	[mlm]				
	LW Y1SG-AEBE-EKFM-1	○ white	0.3 / 0.28	1000 ... 1600	3900	20	120	Q65110A9541	64
	LW Y1SG-AEBE-GKJM-1							Q65110A9542	
	LW Y1SG-AFBF-EKFM-1			Q65110A9543					
	LW Y1SG-AFBF-GKJM-1			Q65110A9544					
	LW Y1SG-BFCF-EKFM-1			Q65110A9545					
	LW Y1SG-BFCF-GKJM-1			Q65110A9546					



Industry Applications

Transportation

OSLON Black

Package	Type	Emission color	λ_{dom} (typ.)/ Cx/Cy	at φ			Viewing angle at 50 % I_V 2 φ typ. [°]	Ordering Code	Package Fig.
				Φ_V	I_V typ.				
			[nm / -]	[lm]	[cd]	[mA]			
	LCW H9GP-JZKY-4R9T-1	○ warm white	0.42 / 0.4	61 ... 97	38.7	350	90	Q65111A0920	5
	LCW H9GP-JZKZ-409Q-1			61 ... 112	42.4			Q65111A0921	
	LCW H9GP-KXLX-4J8K-1			71 ... 130	49.2			Q65111A0923	
	LCW H9GP-JZLX-4L8N-1			61 ... 130	46.8			Q65111A0922	
	LCW H9GP-JZKY-4U9X-1			61 ... 97	38.7			Q65111A0919	
LUW H9GP.CE-KYLY-EMKM-1	○ ultra white	0.31 / 0.32	82 ... 150	55.7	350	90	Q65111A1881	5	

OSRAM OSTAR Headlamp

Package	Type	Emission color	Color coordinates Cx/Cy typ.	at φ		Viewing angle at 50 % I_V 2 φ typ. [°]	Ordering Code	Package Fig.
				Φ_V				
				[lm]	[mA]			
	LE UW D1W1 01-5L6M-GMKM-T01	○ ultra white	0.31 / 0.32	112 ... 224	700	120	Q65110A8591	1
	LE UW D1W2 01-7M7N-GMKM-T01			224 ... 400			Q65110A8590	
	LE UW D1W3 01-7N7P-GMKM-T01			355 ... 630			Q65110A8588	
	LE UW D1W4 01-5P6Q-GMKM-T01			450 ... 900			Q65110A8593	
	LE UW D1W5 01-7P8Q-GMKM-T01			560 ... 1120			Q65110A8589	
	LE UW U1A2 01-5P8P-ebvF68ebzB68	○ ultra white	0.322 / 0.334	450 ... 710	1000	120	Q65111A2089	1
	LE UW U1A3 01-8P8Q-ebvF68ebzB68			630 ... 1120			Q65111A2088	
	LE UW U1A4 01-7Q6R-ebvF68ebzB68			900 ... 1400			Q65111A2087	
	LE UW U1A5 01-5R8R-ebvF68ebzB68			1120 ... 1800			Q65111A2086	

Industry Applications

Transportation

Advanced Power TOPLED Plus

Package	Type	Emission color	λ_{dom} (typ.)/ Cx/Cy	at φ			Viewing angle at 50 % I_V 2 φ typ. [°]	Ordering Code	Package Fig.
				I_V	Φ_V typ.				
			[nm / -]	[mcd]	[mlm]	[mA]			
	LD G5AP-4M4N-35-1	● deep blue	457	25 ... 45	200	100	145	Q65110A8037	59
	LT G5AP-CZEX-36-1	● true green	528	3900 ... 8200	26600			Q65110A8431	
	LR G5AP-BZCZ-1-1	● red	623	2400 ... 4500	15200	100	145	Q65110A8036	59
	LY G5AP-CZDZ-36-1	● yellow	590	3900 ... 7100	24200	100	145	Q65111A1319	59

Package	Type	Emission color	λ_{dom} (typ.)/ Cx/Cy	at φ			Viewing angle at 50 % I_V 2 φ typ. [°]	Ordering Code	Package Fig.
				Φ_V	I_V typ.				
			[nm / -]	[lm]	[cd]	[mA]			
	LCW G5GP-FZHX-5L7N	○ warm white	0.42 / 0.4	15 ... 33	6.4	100	135	Q65110A9081	59
	LCW G5GP-FYGY-5R8T			13 ... 24	5			Q65110A9079	

Dimensions in mm (inch)

Figure 1:

For detailed information
please contact your
OSRAM Sales partner

Figure 2: OSRAM OSTAR Projection Compact

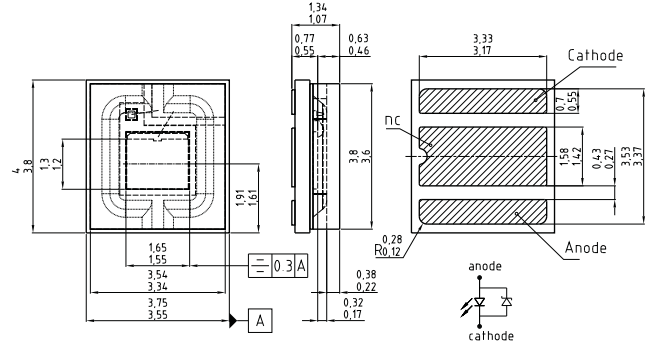

C63062-AA055-A1-10

Figure 3: OSLOX SX

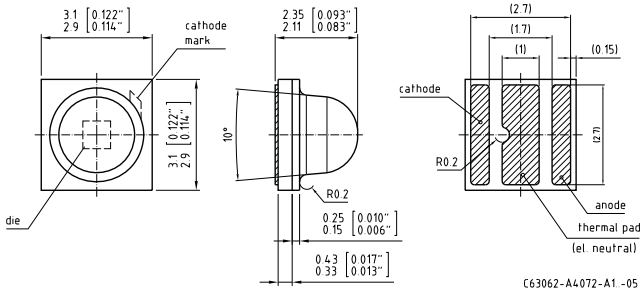

C63062-AA072-A1-05

Figure 4: OSLOX Black Flat

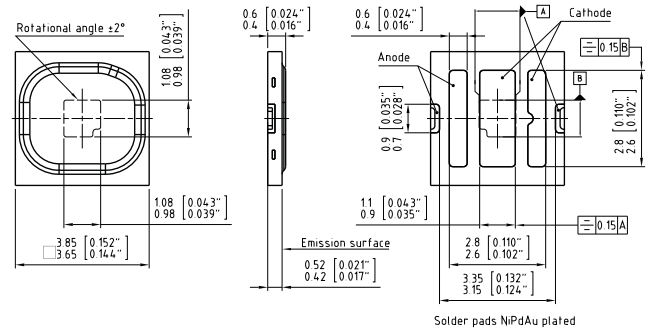

C63062-AA136-A1-06

Figure 5: OSLOX Black

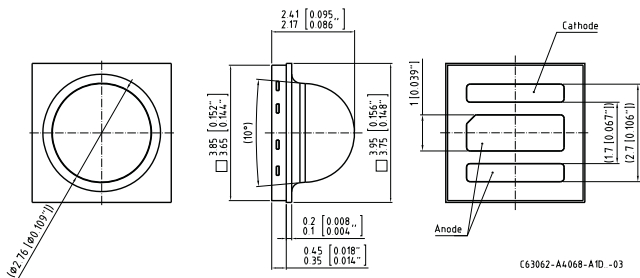

C63062-AA068-A1D-03

Figure 6: Golden DRAGON

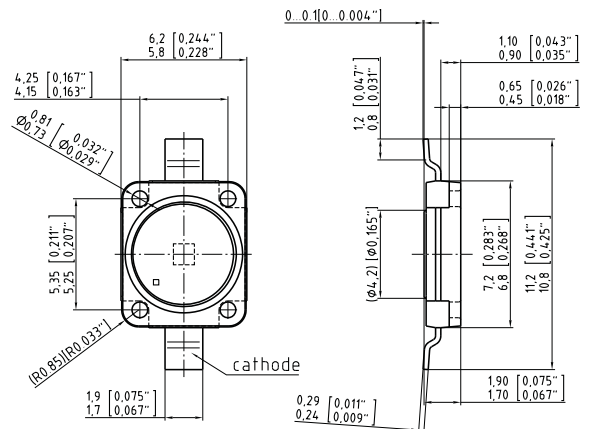

C63062-A3904-A1-05

Dimensions in mm (inch)

Figure 7: Golden DRAGON

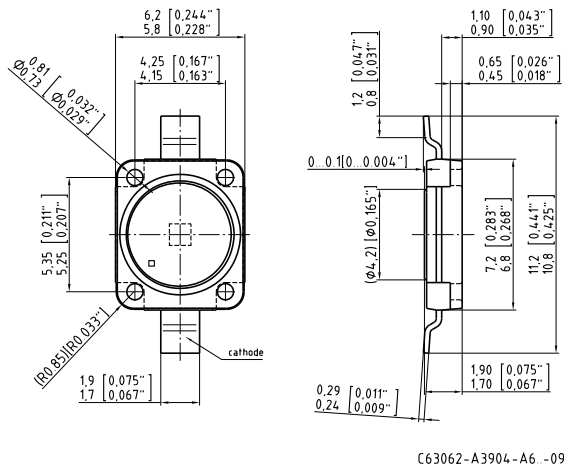

Figure 8: Platinum DRAGON

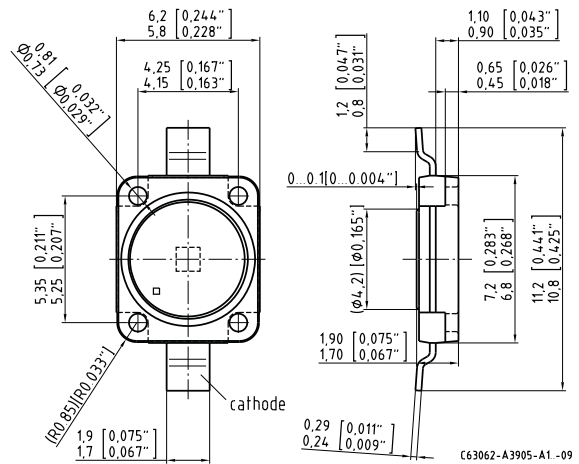

Figure 9: Advanced Power TOPLED

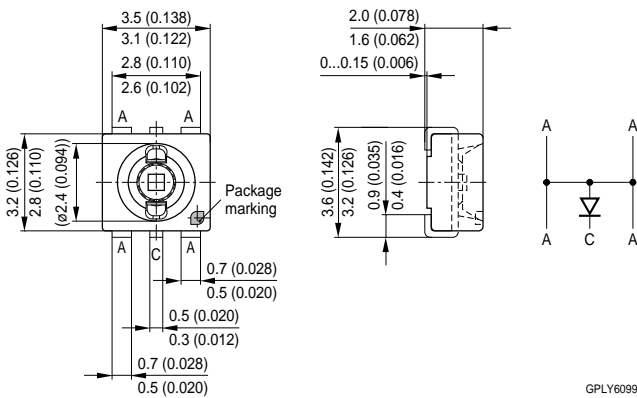

Figure 10: Advanced Power TOPLED

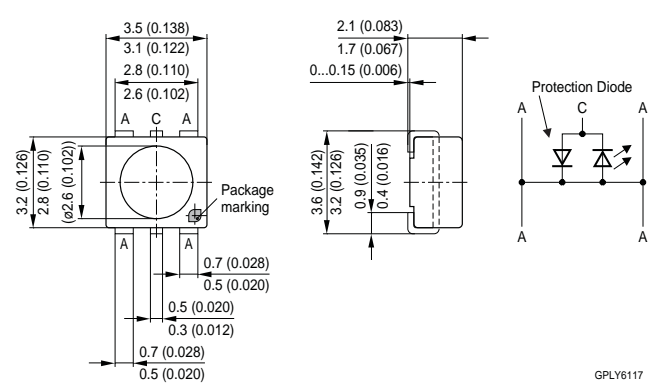

Figure 11: Power TOPLED

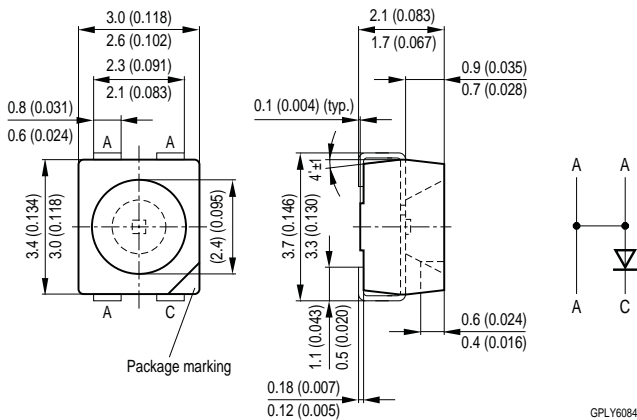
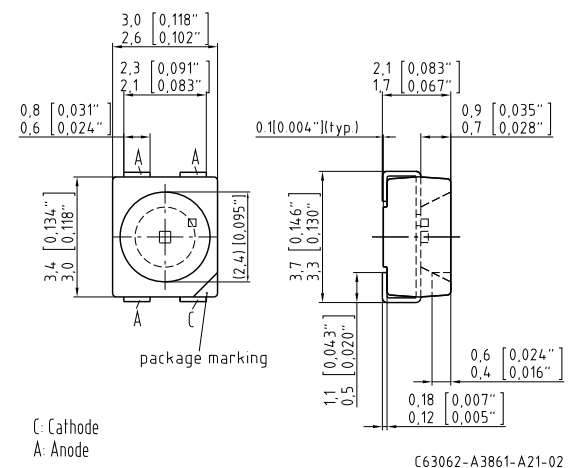

Figure 12: Power TOPLED



Dimensions in mm (inch)

Figure 13: Power TOPLED with lens

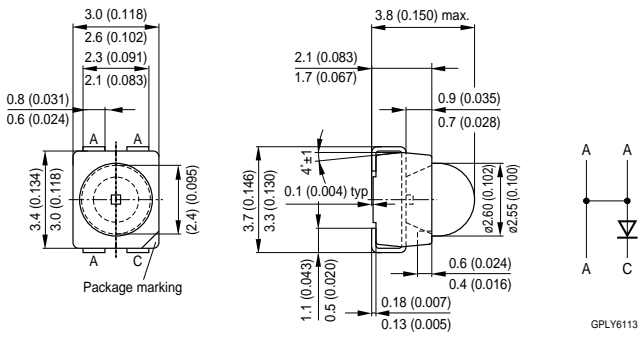

Figure 14: Power TOPLED with lens

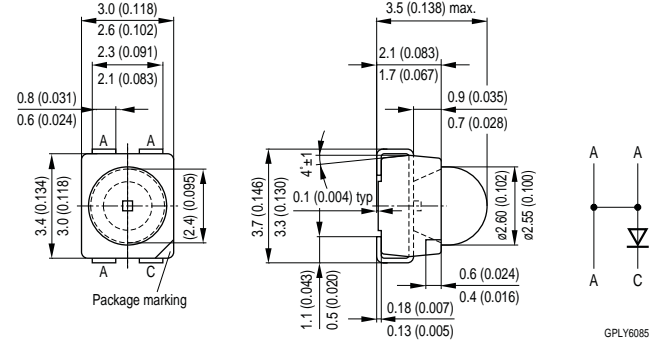

Figure 15: MULTILED

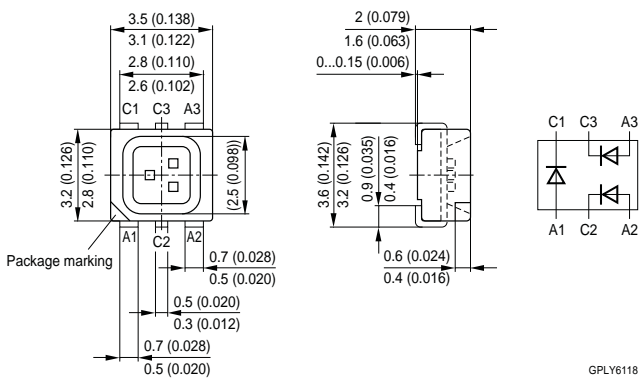

Figure 16: Multi TOPLED

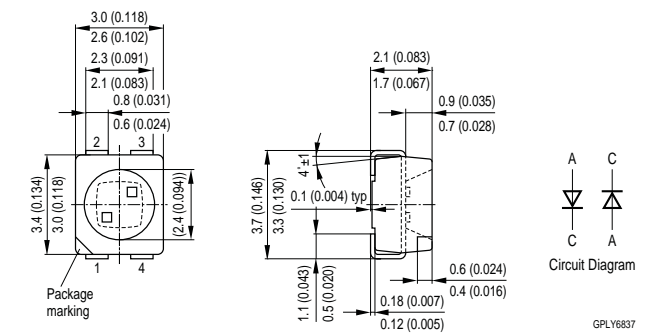

Figure 17: OSLO SX

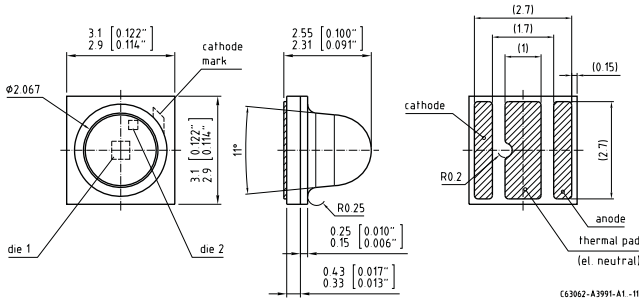
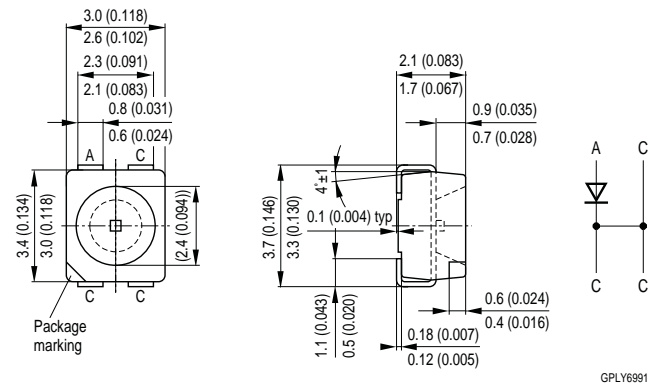

Figure 18: Power TOPLED



Dimensions in mm (inch)

Figure 19: Power TOPLED with lens

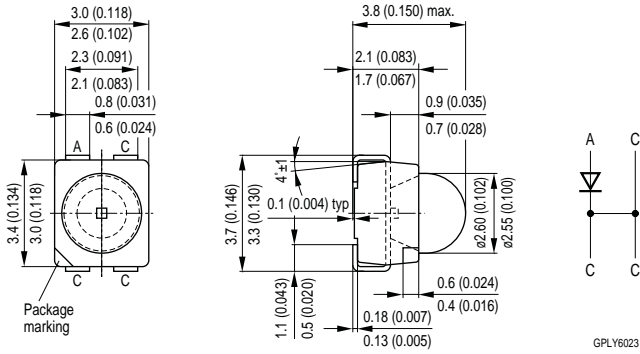

Figure 20: Power TOPLED with lens

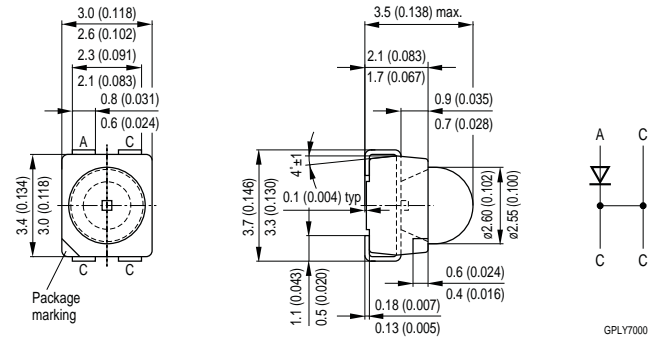

Figure 21: TOPLED

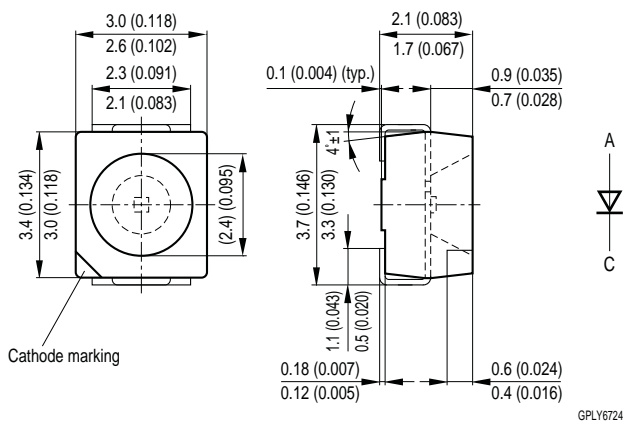

Figure 22: SIDELED

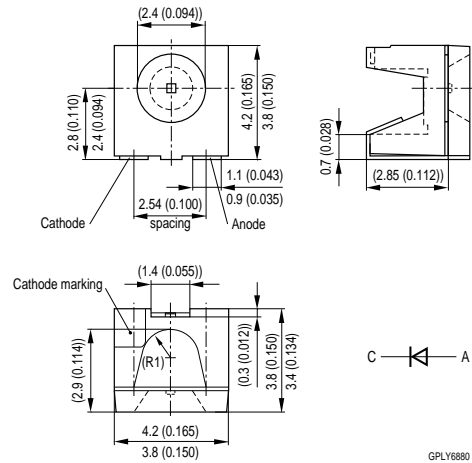

Figure 23: Mini TOPLED

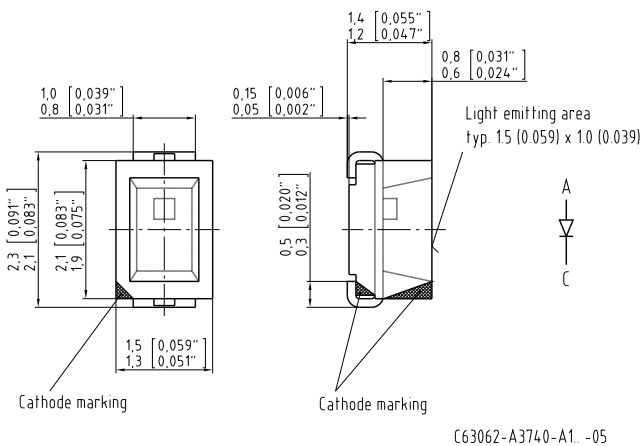
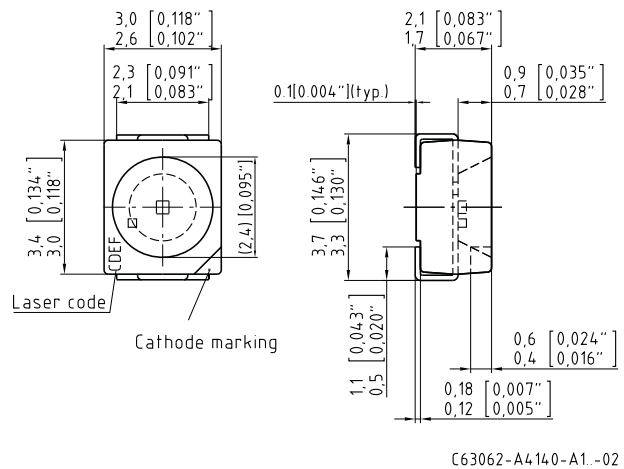

Figure 24: TOPLED



Dimensions in mm (inch)

Figure 25: SMARTLED 0603

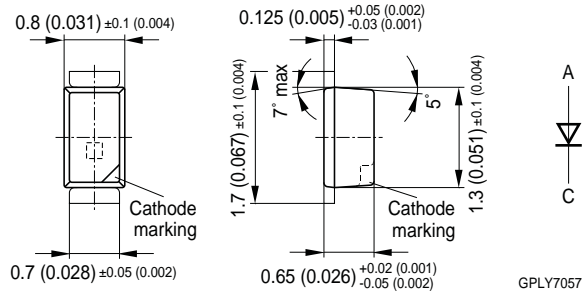

Figure 26: SMARTLED XR

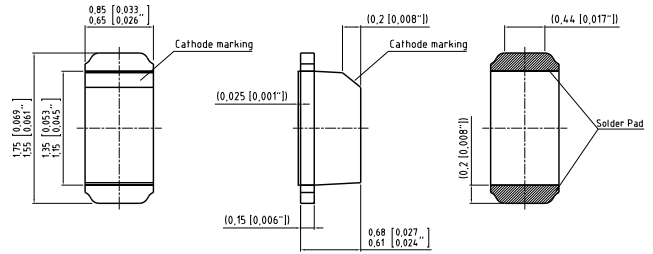

Figure 27: PointLED

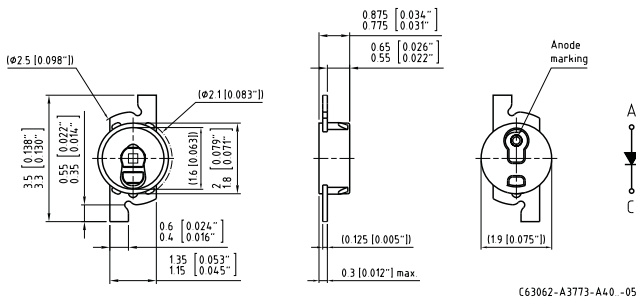

Figure 28: Mini TOPLED

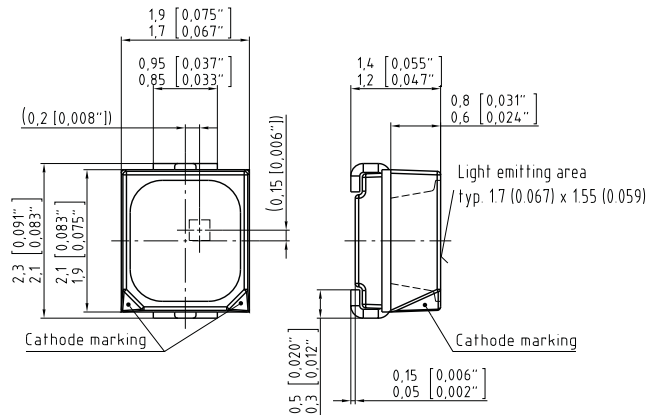

Figure 29: Micro SIDELED

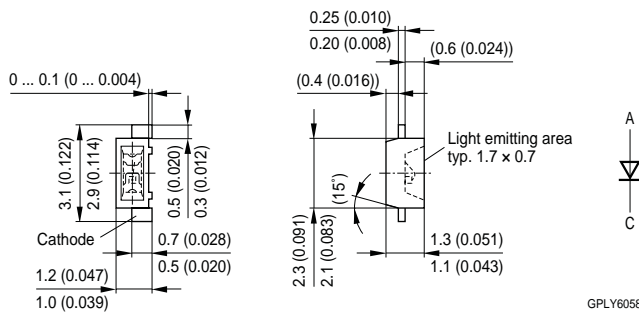
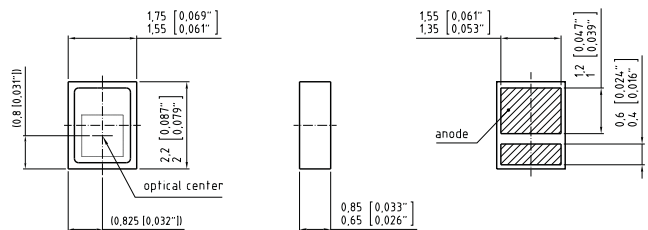
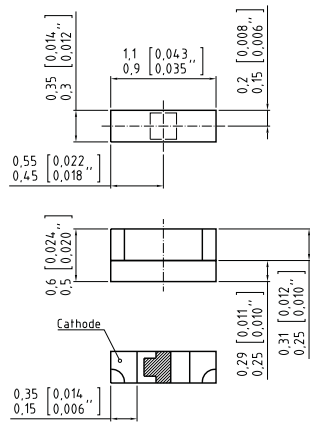

Figure 30: CERAMOS



Dimensions in mm (inch)

Figure 31: FIREFLY



C63062-A4024-A1-03

Figure 32: Multi CERAMOS

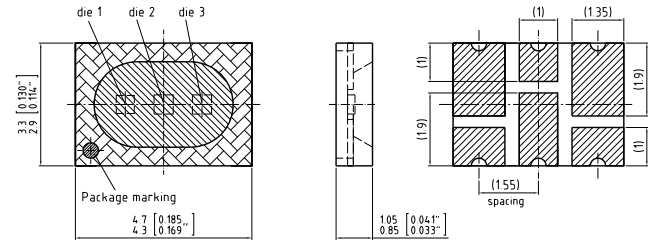

C63062-A3928-A1-08

Figure 33: OSRAM OSTAR Projection Cube

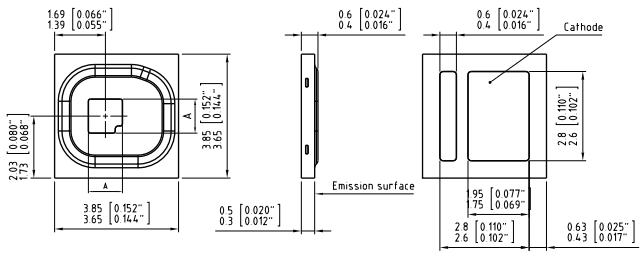

C63062-A4135-A1-05

Figure 34: OSRAM OSTAR Projection Compact

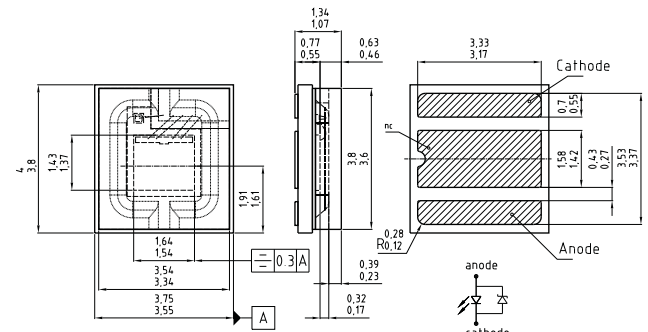

C63062-A4055-A3-05

Figure 35: OSRAM OSTAR Projection Compact

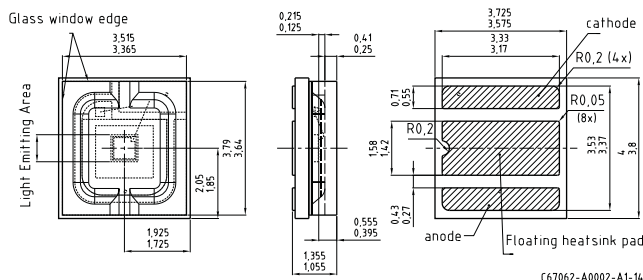

C67062-A0002-A1-14

Figure 36: OSRAM OSTAR Projection Compact

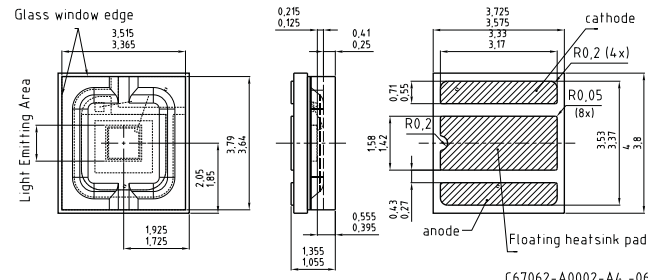

C67062-A0002-A4-06

Dimensions in mm (inch)

Figure 37: OSRAM OSTAR Projection Compact

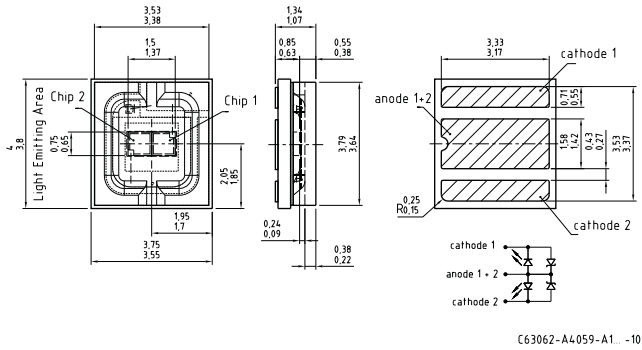

C63062-A4-059-A1 - 10

Figure 38: OSRAM OSTAR Projection Compact

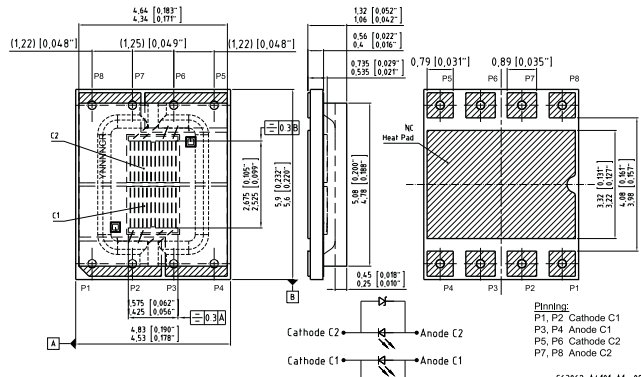

C63062-A4-101-A1 - 09

Figure 39: OSLOL LX

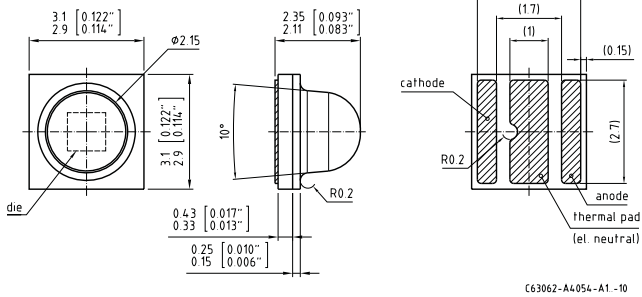

C63062-A4-054-A1 - 10

Figure 40: TOPLED Black

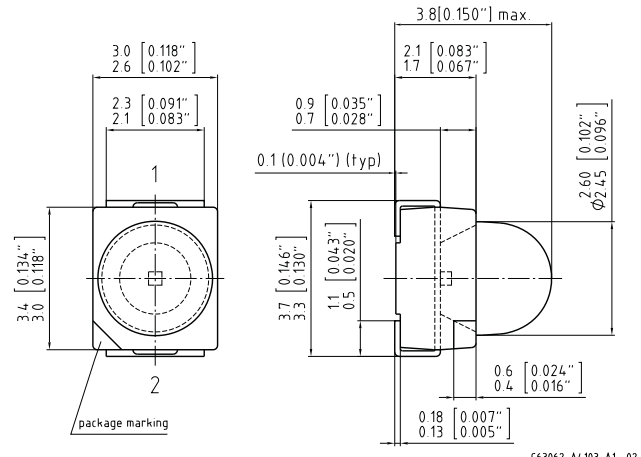

C63062-A4-103-A1 - 02

Figure 41: MULTILED

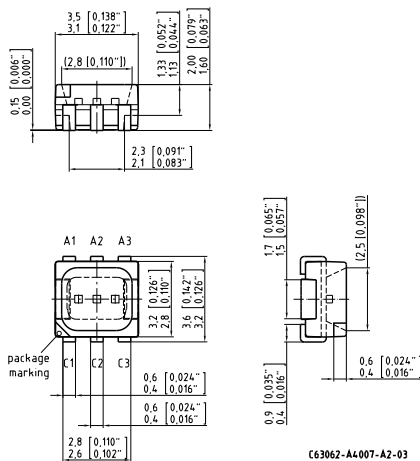

C63062-A4-007-A2-03

Figure 42: MULTILED

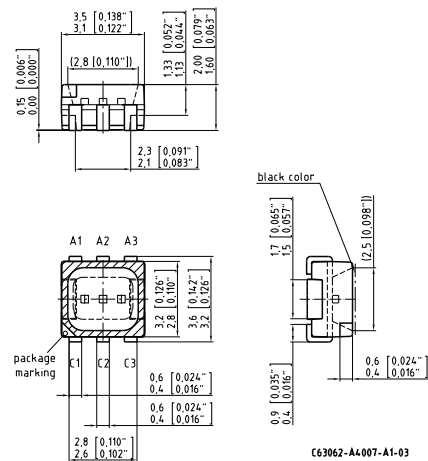

C63062-A4-007-A1-03

Dimensions in mm (inch)

Figure 43: Multi CHIPLED

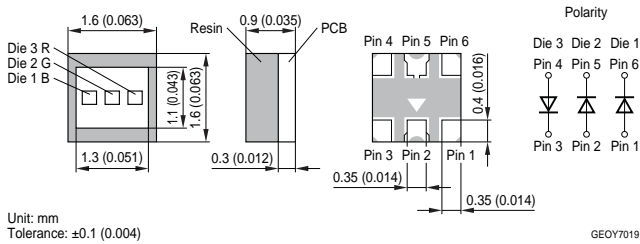

Figure 44: OSRAM OSTAR Projection SMT

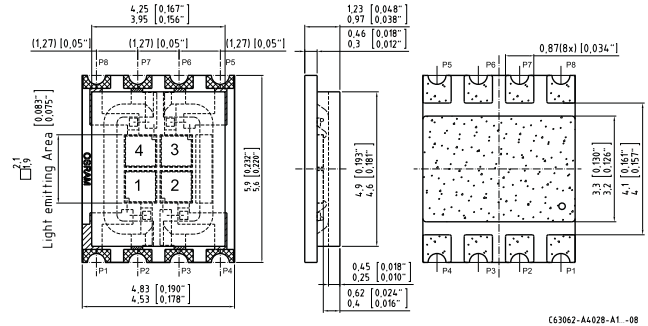

Figure 45: CHIPLED 1206

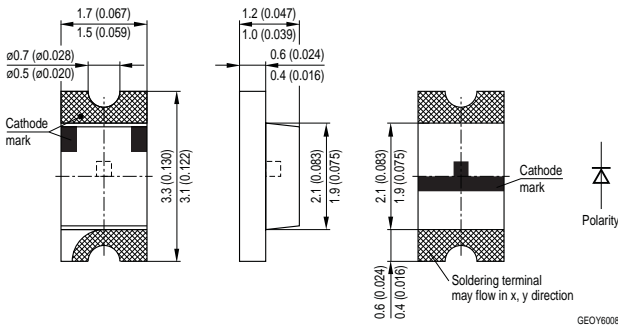

Figure 46: CHIPLED 0805

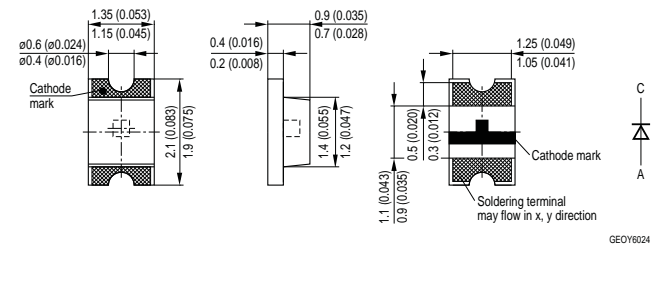

Figure 47: CHIPLED 0603

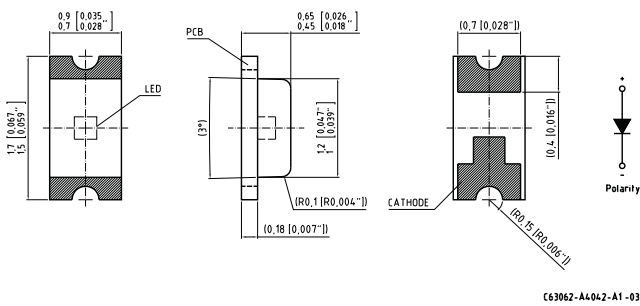
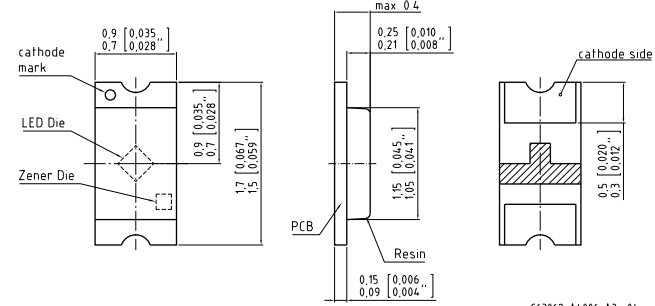

Figure 48: CHIPLED 0603



Dimensions in mm (inch)

Figure 49: CHIPLED 0402

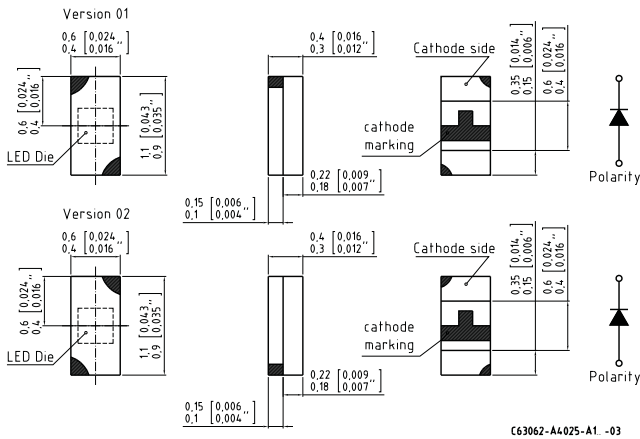

Figure 50: CHIPLED with lens

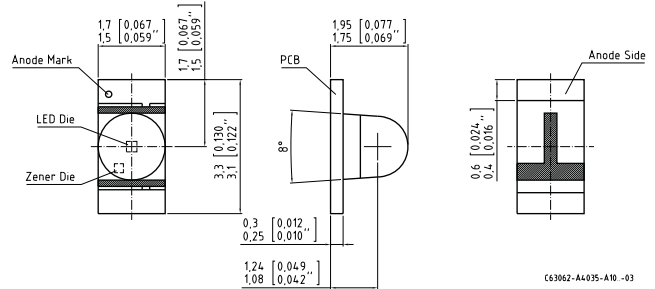

Figure 51: Multi TOPLED RG

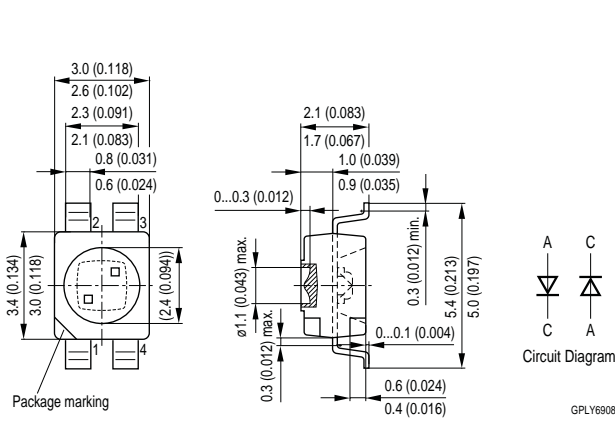

Figure 52: TOPLED

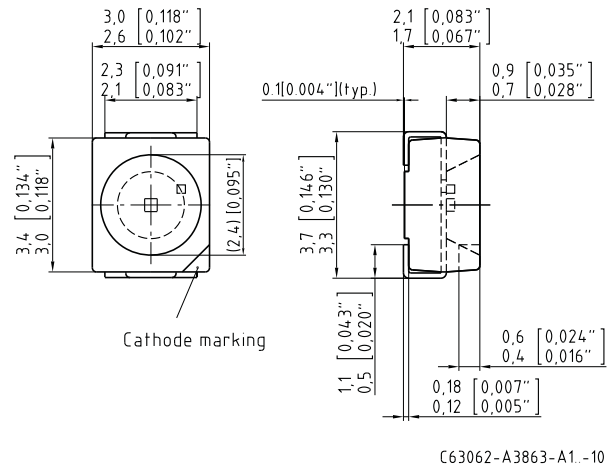

Figure 53: SIDELED

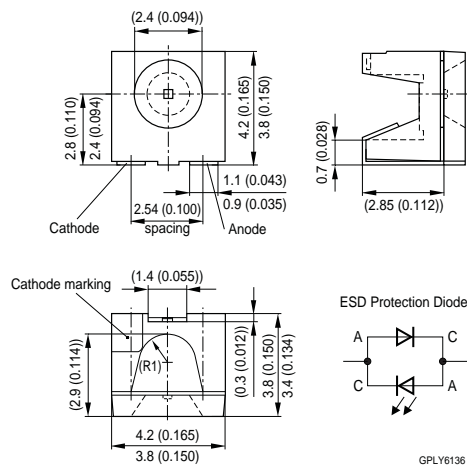
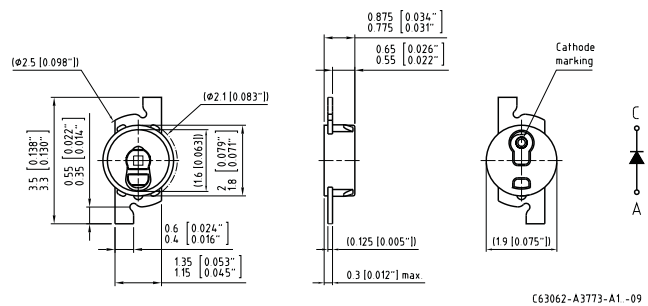
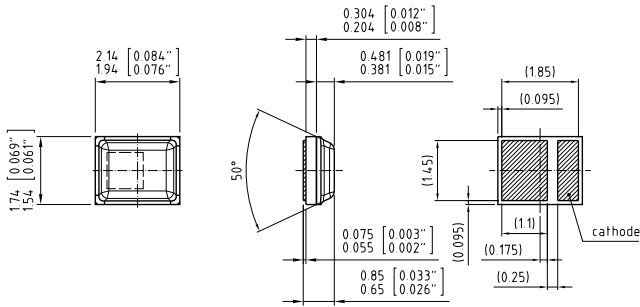

Figure 54: PointLED



Dimensions in mm (inch)

Figure 55: CERAMOS



C63062-A4053-A1 -06

Figure 56: OSRAM OSTAR Projection Compact

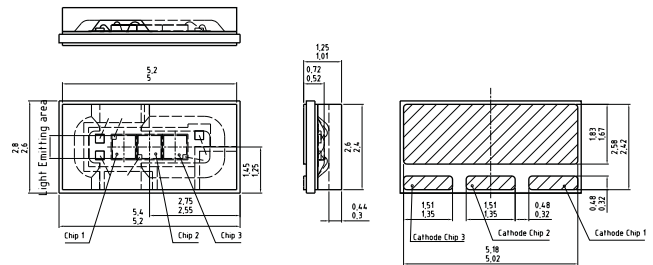

C63062-A4076-A1 -04

Figure 57: TOPLED Black

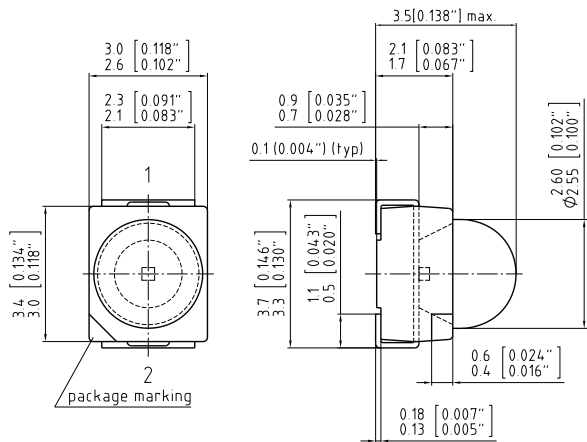

C63062-A3725-A1 -08

Figure 58: MULTILED

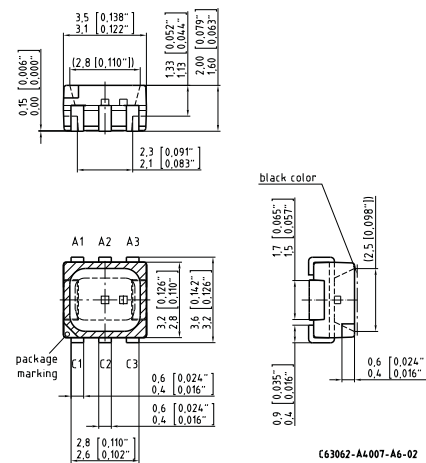

C63062-A4007-A6-02

Figure 59: Advanced Power TOPLED Plus

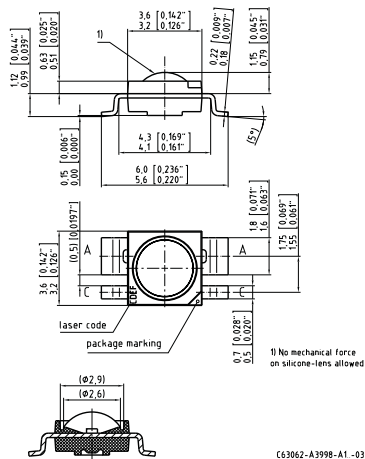

C63062-A3998-A1 -03

Figure 60: CHIPLD 1206

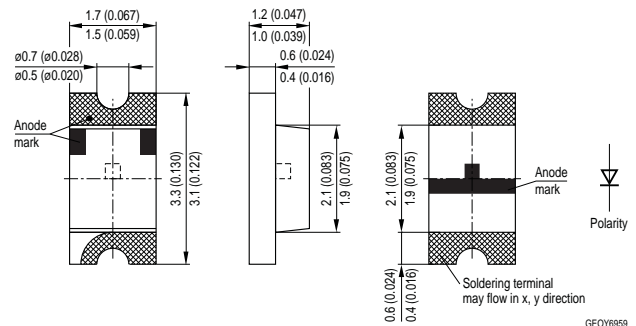

GEOY6959

Dimensions in mm (inch)

Figure 61: CHIPLED 0603

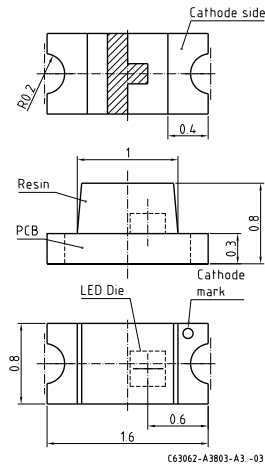

Figure 62: Multi CHIPLED

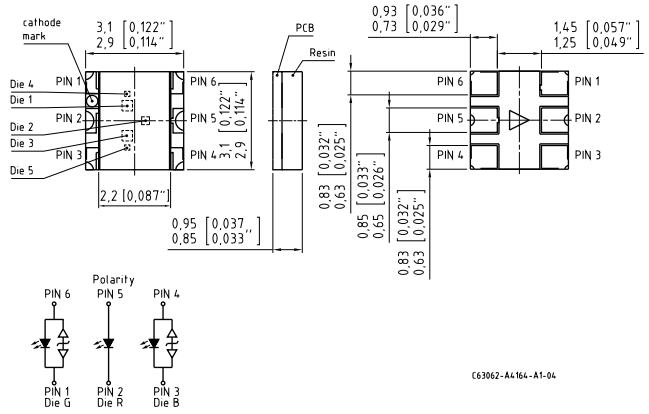

Figure 63: TOPLED Compact

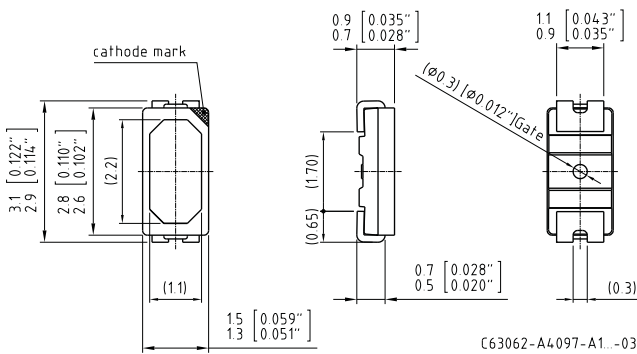
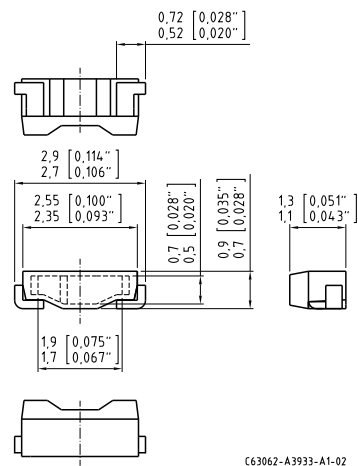

Figure 64: Micro SIDELED



Dimensions in mm (inch)

Figure 65: TOPLED

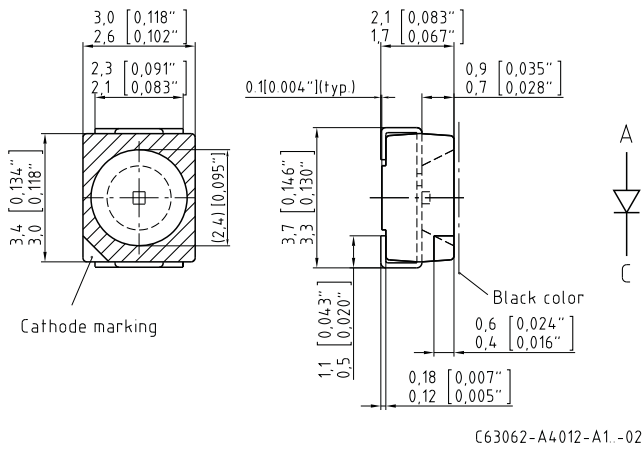
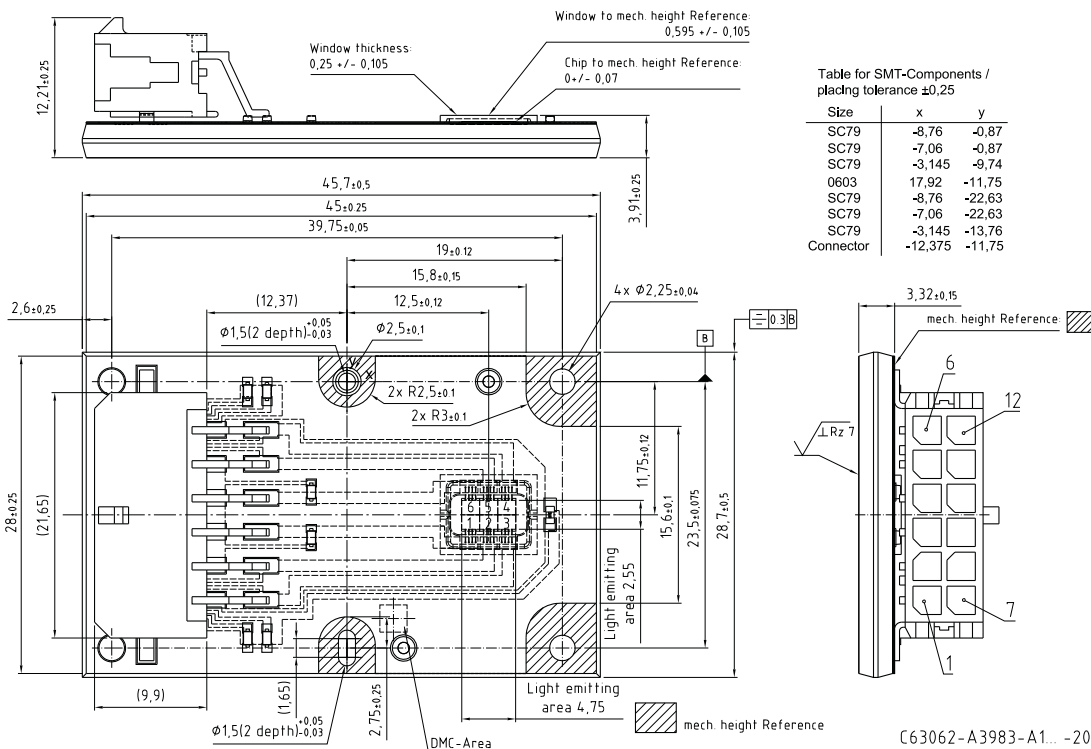
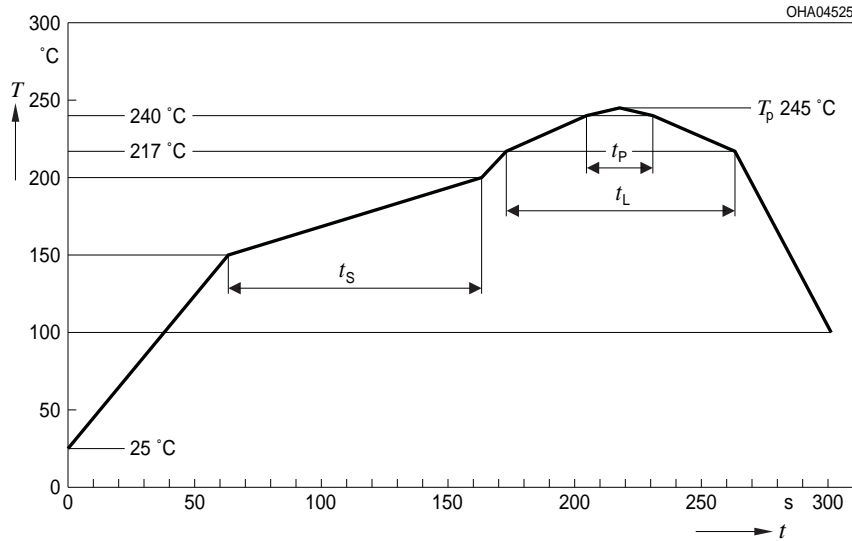

Figure 66: OSRAM OSTAR Projection Power



Reflow soldering profile acc. to J-STD-020D.01



Components under 2.5 mm height

OHA04612

Profil-Charakteristik Profile Feature	Symbol Symbol	Pb-Free (SnAgCu) Assembly			Einheit Unit
		Minimum	Recommendation	Maximum	
Ramp-up Rate to Preheat*) $25\text{ °C} \leq T \leq 150\text{ °C}$			2	3	K/s
Time from T_{Smin} to T_{Smax} $150\text{ °C} \leq T_S \leq 200\text{ °C}$	t_s	60	100	120	s
Ramp-up Rate to Peak*) $T_{Smax} \leq T \leq T_p$			2	3	K/s
Liquidus Temperature	T_L	217			°C
Time above Liquidus temperature	t_L		80	100	s
Time $25\text{ °C} \leq T \leq T_p$				480	s
Peak Temperature	T_p		245	260	°C
Time within 5 °C of the specified peak temperature $T_p - 5\text{ K}$	t_p	10	20	30	s
Ramp-down Rate* $T_p \leq T \leq 100\text{ °C}$			3	6	K/s

All temperatures refer to the center of the package, measured on the top of the component
 * slope calculation $\Delta T/\Delta t$: Δt max. 5 s; fulfillment for the whole T-range

Reflow soldering profile acc. to J-STD-020D.01

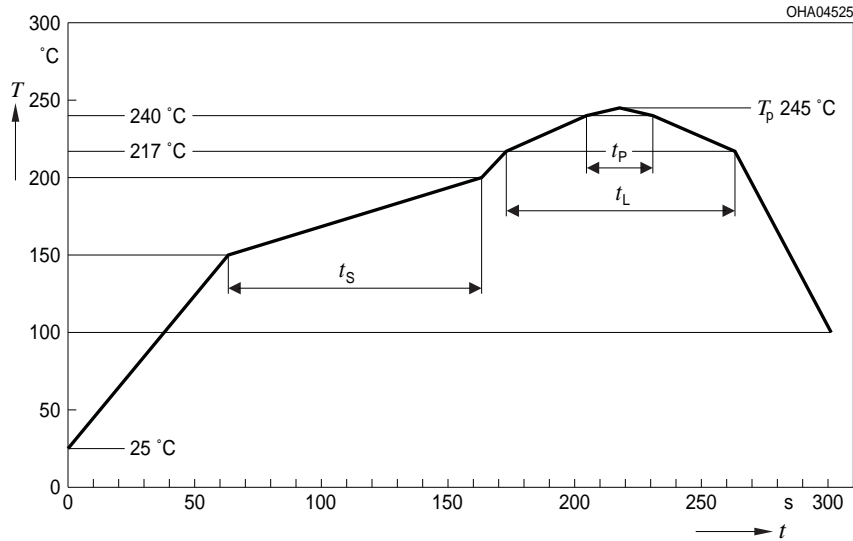

Components over 2.5 mm height

OHA04613

Profil-Charakteristik Profile Feature	Symbol Symbol	Pb-Free (SnAgCu) Assembly			Einheit Unit
		Minimum	Recommendation	Maximum	
Ramp-up Rate to Preheat*) 25 °C ≤ T ≤ 150 °C			2	3	K/s
Time from T _{Smin} to T _{Smax} 150 °C ≤ T _S ≤ 200 °C	t _S	60	100	120	s
Ramp-up Rate to Peak*) T _{Smax} ≤ T ≤ T _P			2	3	K/s
Liquidus Temperature	T _L	217			
Time above Liquidus temperature	t _L		80	100	s
Time 25 °C ≤ T ≤ T _P				480	s
Peak Temperature	T _P		245	250	°C
Time within 5 °C of the specified peak temperature T _P - 5 K	t _p	10	20	30	s
Ramp-down Rate* T _P ≤ T ≤ 100 °C			3	4	K/s

All temperatures refer to the center of the package, measured on the top of the component
 * slope calculation $\Delta T/\Delta t$: Δt max. 5 s; fulfillment for the whole T-range

OSRAM OSTAR type designation system

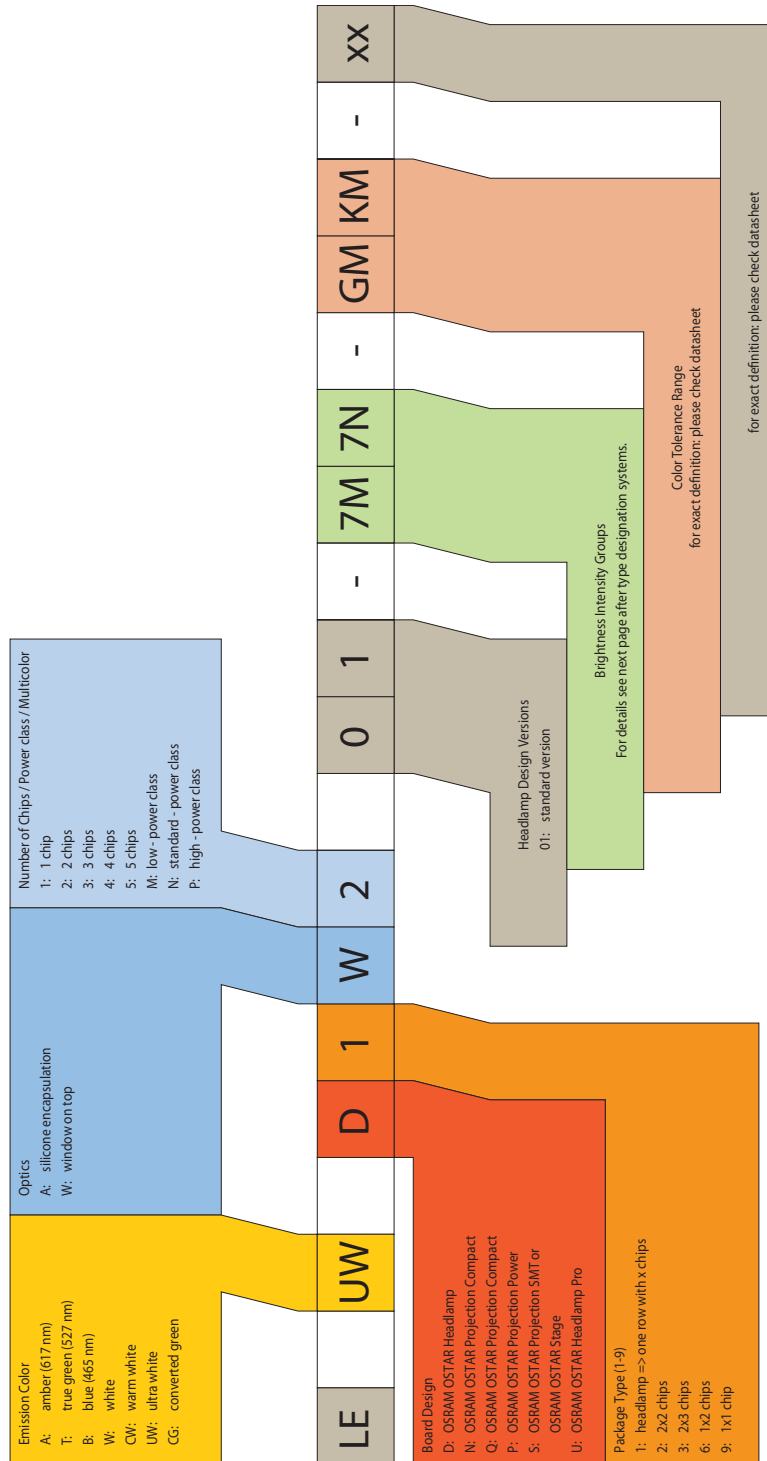

Premolded LED type designation system

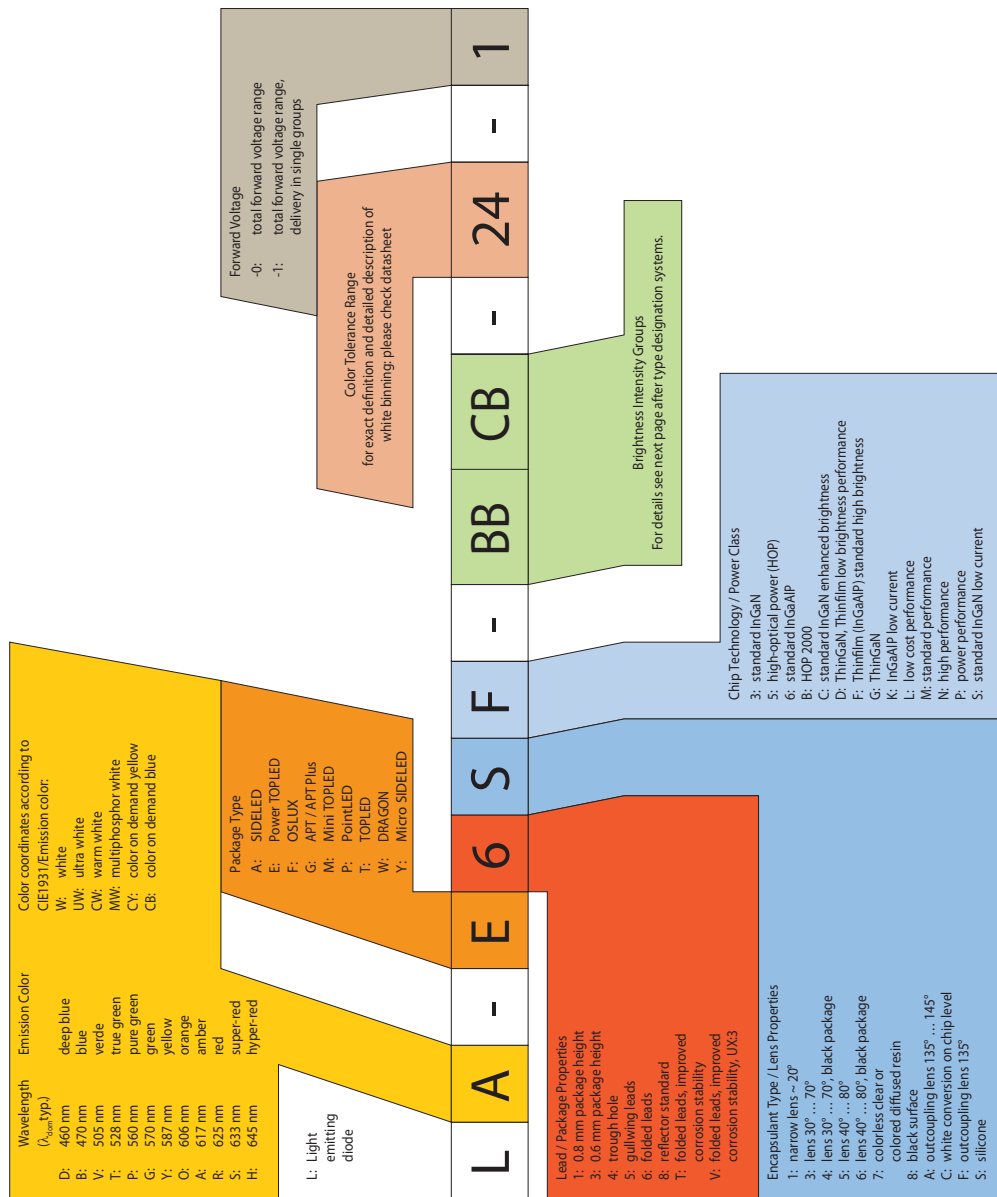

Taping of LEDs

All SMT LEDs are available in 8 mm resp. 12 mm tapes.

Gurtung von Lumineszenzdioden

Alle SMT-LED werden im 8- bzw. 12-mm Gurt geliefert.

Ceramics based LED type designation system

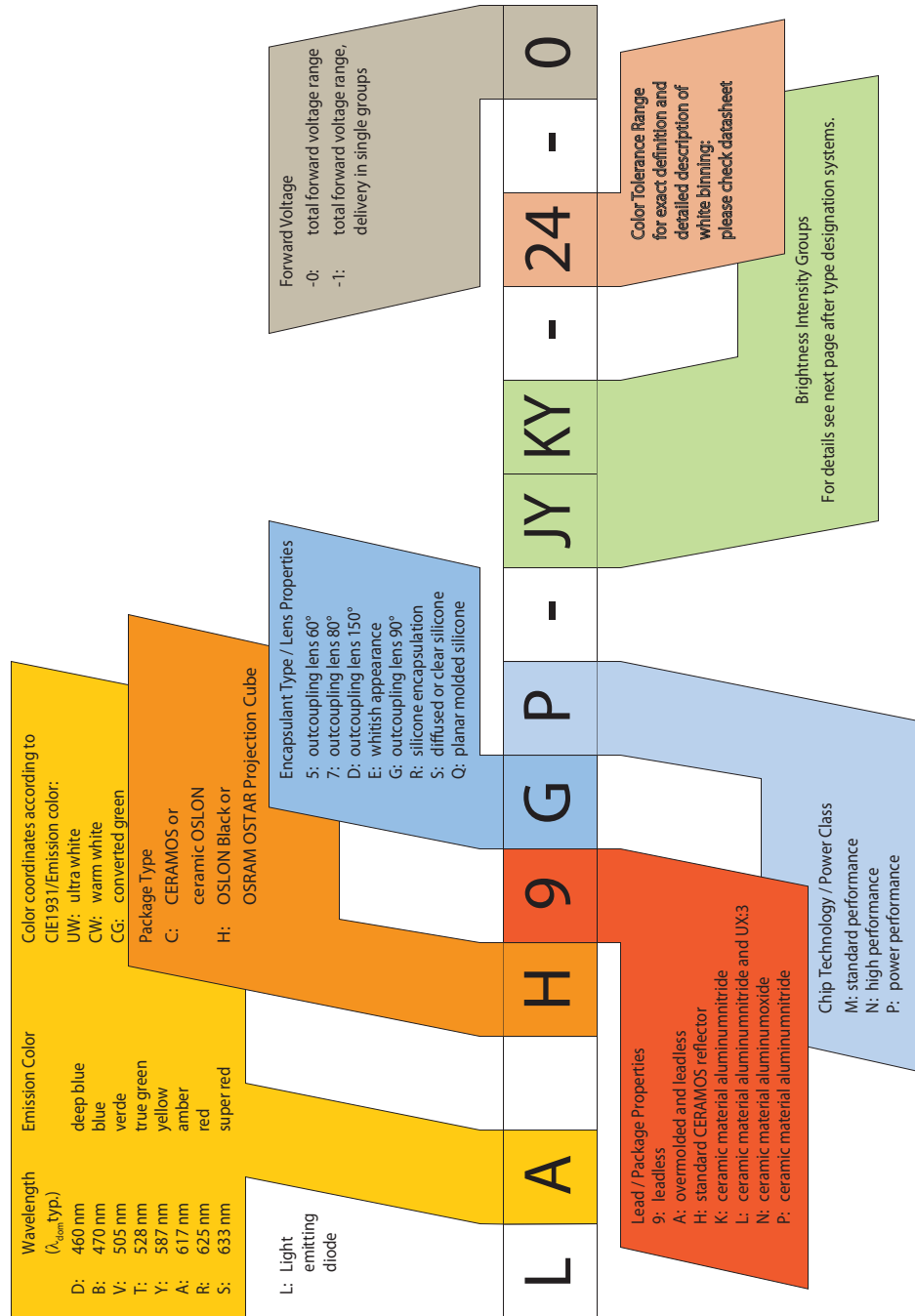

Taping of LEDs

All SMT LEDs are available in 8 mm resp. 12 mm tapes.

Gurtung von Lumineszenzdioden

Alle SMT-LED werden im 8- bzw. 12-mm Gurt geliefert.

Miniature package LED type designation system

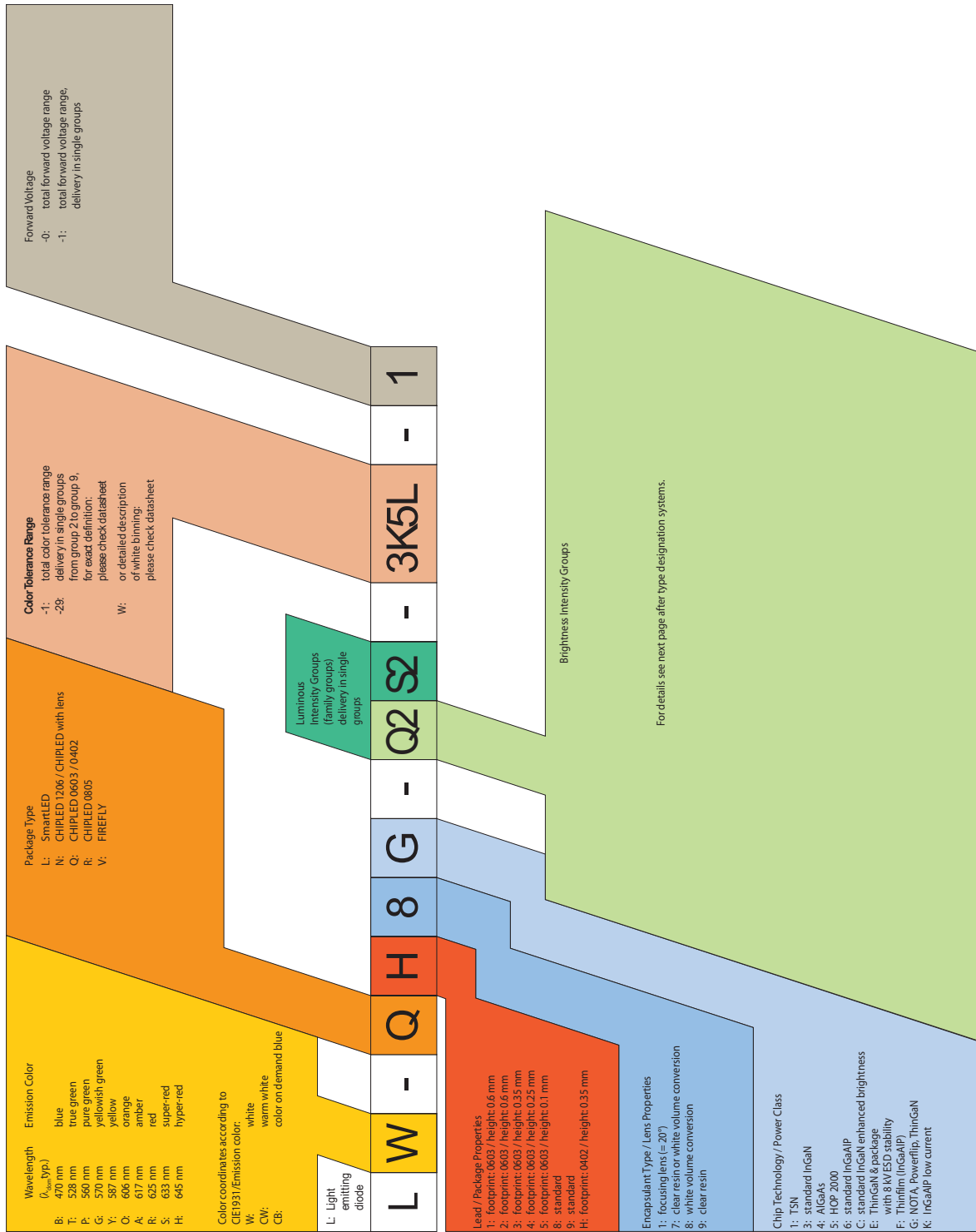

Taping of LEDs

All SMT LEDs are available in 8 mm resp. 12 mm tapes.

Gurtung von Lumineszenzdioden

Alle SMT-LED werden im 8- bzw. 12-mm Gurt geliefert.

Multi chip LED type designation system

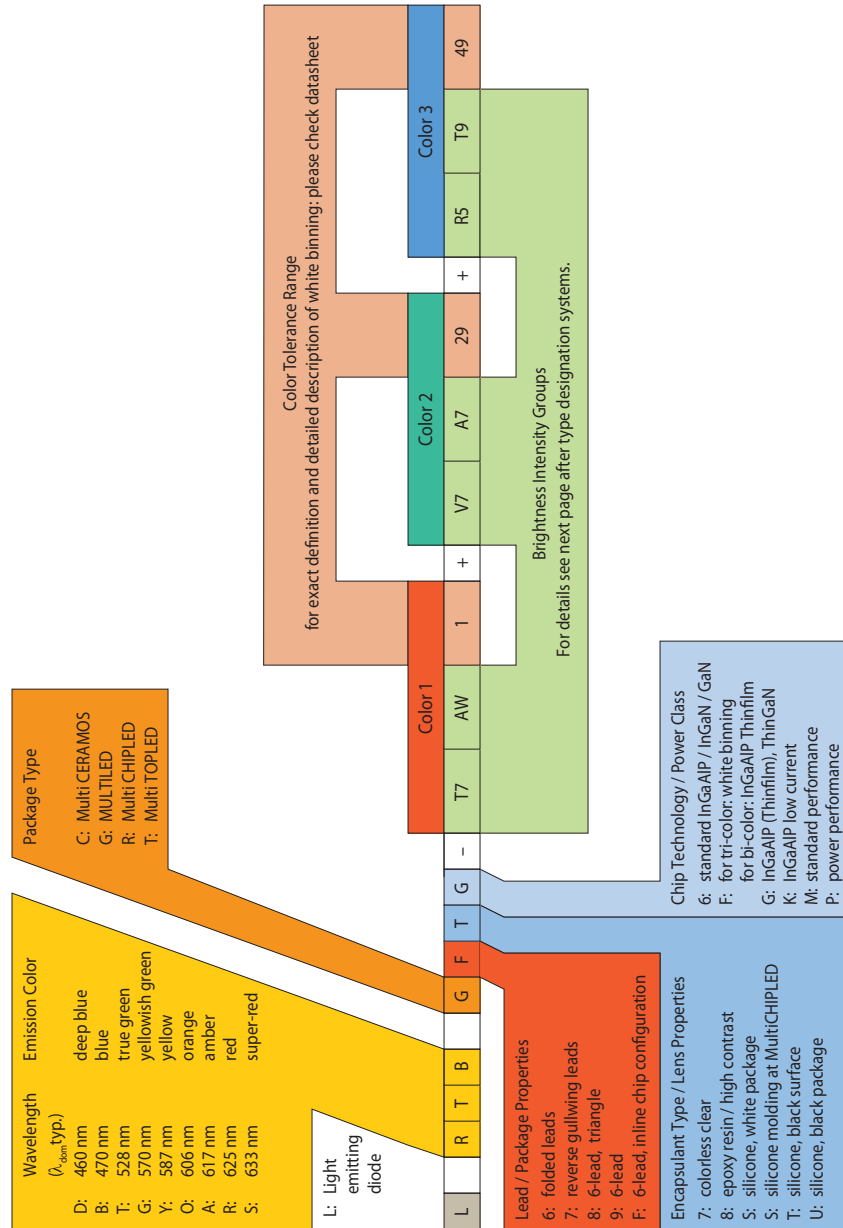

Taping of LEDs

All SMT LEDs are available in 8 mm resp. 12 mm tapes.

Gurtung von Lumineszenzdioden

Alle SMT-LED werden im 8- bzw. 12-mm Gurt geliefert.

Brightness Intensity Groups

1/1 Grouping (cont.)			1/2 Grouping (cont.)			1/3 Grouping (cont.)			1/4 Grouping (cont.)			1/6 Grouping (cont.)		
Bin	min.	max.	Bin	min.	max.	Bin	min.	max.	Bin	min.	max.	Bin	min.	max.
EW	7 100	11 200	EA	7 100	9 000	EX	7 100	8 200	5E	7 100	8 000	EP	7 100	7 630
			EB	9 000	11 200	EY	8 200	9 700	6E	8 000	9 000	EQ	7 630	8 200
						EZ	9 700	11 200	7E	9 000	10 000	ER	8 200	8 920
									8E	10 000	11 200	ES	8 920	9 700
												ET	9 700	10 420
												EU	10 420	11 200
FW	11 200	18 000	FA	11 200	14 000	FX	11 200	13 000	5F	11 200	12 500	FP	11 200	12 100
			FB	14 000	18 000	FY	13 000	15 000	6F	12 500	14 000	FQ	12 100	13 000
						FZ	15 000	18 000	7F	14 000	15 900	FR	13 000	14 000
									8F	15 900	18 000	FS	14 000	15 000
												FT	15 000	16 400
												FU	16 400	18 000
GW	18 000	28 000	GA	18 000	22 400	GX	18 000	21 000	5G	18 000	20 100	GP	18 000	19 400
			GB	22 400	28 000	GY	21 000	24 000	6G	20 100	22 400	GQ	19 400	21 000
						GZ	24 000	28 000	7G	22 400	25 000	GR	21 000	22 400
									8G	25 000	28 000	GS	22 400	24 000
												GT	24 000	25 900
												GU	25 900	28 000
HW	28 000	45 000	HA	28 000	35 500	HX	28 000	33 000	5H	28 000	31 500	HP	28 000	30 400
			HB	35 500	45 000	HY	33 000	39 000	6H	31 500	35 500	HQ	30 400	33 000
						HZ	39 000	45 000	7H	35 500	40 000	HR	33 000	35 900
									8H	40 000	45 000	HS	35 900	39 000
												HT	39 000	41 900
												HU	41 900	45 000
JW	45 000	71 000	JA	45 000	56 000	JX	45 000	52 000	5J	45 000	50 000	JP	45 000	48 400
			JB	56 000	71 000	JY	52 000	61 000	6J	50 000	56 000	JQ	48 400	52 000
						JZ	61 000	71 000	7J	56 000	63 000	JR	52 000	56 300
									8J	63 000	71 000	JS	56 300	61 000
												JT	61 000	65 800
												JU	65 800	71 000
KW	71 000	112 000	KA	71 000	90 000	KX	71 000	82 000	5K	71 000	80 000	KP	71 000	76 300
			KB	90 000	112 000	KY	82 000	97 000	6K	80 000	90 000	KQ	76 300	82 000
						KZ	97 000	112 000	7K	90 000	100 000	KR	82 000	89 200
									8K	100 000	112 000	KS	89 200	97 000
												KT	97 000	104 200
												KU	104 200	112 000
LW	112 000	180 000	LA	112 000	140 000	LX	112 000	130 000	5L	112 000	125 000	LP	112 000	121 000
			LB	140 000	180 000	LY	130 000	150 000	6L	125 000	140 000	LQ	121 000	130 000
						LZ	150 000	180 000	7L	140 000	159 000	LR	130 000	140 000
									8L	159 000	180 000	LS	140 000	150 000
												LT	150 000	164 000
												LU	164 000	180 000
MW	180 000	280 000	MA	180 000	224 000	MX	180 000	210 000	5M	180 000	201 000	MP	180 000	194 000
			MB	224 000	280 000	MY	210 000	240 000	6M	201 000	224 000	MQ	194 000	210 000
						MZ	240 000	280 000	7M	224 000	250 000	MR	210 000	224 000
									8M	250 000	280 000	MS	224 000	240 000
												MT	240 000	259 000
												MU	259 000	280 000
NW	280 000	450 000	NA	280 000	355 000	NX	280 000	330 000	5N	280 000	315 000	NP	280 000	304 000
			NB	355 000	450 000	NY	330 000	390 000	6N	315 000	355 000	NQ	304 000	330 000
						NZ	390 000	450 000	7N	355 000	400 000	NR	330 000	359 000
									8N	400 000	450 000	NS	359 000	390 000
												NT	390 000	419 000
												NU	419 000	450 000
PW	450 000	710 000	PA	450 000	560 000	PX	450 000	520 000	5P	450 000	500 000	PP	450 000	484 000
			PB	560 000	710 000	PY	520 000	610 000	6P	500 000	560 000	PQ	484 000	520 000
						PZ	610 000	710 000	7P	560 000	630 000	PR	520 000	563 000
									8P	630 000	710 000	PS	563 000	610 000
												PT	610 000	658 000
												PU	658 000	710 000
QW	710 000	1 120 000	QA	710 000	900 000	QX	710 000	820 000	5Q	710 000	800 000	QP	710 000	763 000
			QB	900 000	1 120 000	QY	820 000	970 000	6Q	800 000	900 000	QQ	763 000	820 000
						QZ	970 000	1 120 000	7Q	900 000	1 000 000	QR	820 000	892 000
									8Q	1 000 000	1 120 000	QS	892 000	970 000
												QT	970 000	1 042 000
												QU	1 042 000	1 120 000
RW	1 120 000	1 800 000	RA	1 120 000	1 400 000	RX	1 120 000	1 300 000	5R	1 120 000	1 250 000	RP	1 120 000	1 210 000
			RB	1 400 000	1 800 000	RY	1 300 000	1 500 000	6R	1 250 000	1 400 000	RQ	1 210 000	1 300 000
						RZ	1 500 000	1 800 000	7R	1 400 000	1 590 000	RR	1 300 000	1 400 000
									8R	1 590 000	1 800 000	RS	1 400 000	1 500 000
												RT	1 500 000	1 640 000
												RU	1 640 000	1 800 000
SW	1 800 000	2 800 000	SA	1 800 000	2 240 000	SX	1 800 000	2 100 000	5S	1 800 000	2 010 000	SP	1 800 000	1 940 000
			SB	2 240 000	2 800 000	SY	2 100 000	2 400 000	6S	2 010 000	2 240 000	SQ	1 940 000	2 100 000
						SZ	2 400 000	2 800 000	7S	2 240 000	2 500 000	SR	2 100 000	2 240 000
									8S	2 500 000	2 800 000	SS	2 240 000	2 400 000
												ST	2 400 000	2 590 000
												SU	2 590 000	2 800 000
TW	2 800 000	4 500 000	TA	2 800 000	3 550 000	TX	2 800 000	3 300 000	5T	2 800 000	3 150 000	TP	2 800 000	3 040 000
			TB	3 550 000	4 500 000	TY	3 300 000	3 900 000	6T	3 150 000	3 550 000	TQ	3 040 000	3 300 000
						TZ	3 900 000	4 500 000	7T	3 550 000	4 000 000	TR	3 300 000	3 590 000
									8T	4 000 000	4 500 000	TS	3 590 000	3 900 000
												TT	3 900 000	4 190 000
												TU	4 190 000	4 500 000
UW	4 500 000	7 100 000	UA	4 500 000	5 600 000	UX	4 500 000	5 200 000	5U	4 500 000	5 000 000	UP	4 500 000	4 840 000
			UB	5 600 000	7 100 000	UY	5 200 000	6 100 000	6U	5 000 000	5 600 000	UQ	4 840 000	5 200 000
						UZ	6 100 000	7 100 000	7U	5 600 000	6 300 000	UR	5 200 000	5 630 000
									8U	6 300 000	7 100 000	US	5 630 000	6 100 000
												UT	6 100 000	6 580 000
												UU	6 580 000	7 100 000
VW	7 100 000	11 200 000	VA	7 100 000	9 000 000	VX	7 100 000	8 200 000	5V	7 100 000	8 000 000	VP	7 100 000	